

Comptec

Comptec Door Drive 5.0 (CDD 5.0)

Lift door Controller

USER MANUAL

FW reference version: 02.00.000

EN	CE					PRJ1166_03_07_02_IUM	Rev.01
----	----	---	---	---	---	----------------------	--------

Index

Index of tables	4
Introduction	5
Glossary	6
1 Technical Specifications	7
1.1 Standards and Codes References	7
1.2 Door Drive Data	7
1.3 Compatible Motors Data	7
1.4 System mechanical data	7
2 Generalities	8
2.1 Intended use	8
2.2 System overview	8
2.3 Compatibility for applications and motors	9
3 Installation	10
3.1 Preliminary mechanical checks	10
3.2 Mechanical Installation	11
3.3 Preliminary electrical checks	11
3.4 Check of electrical parts	12
3.5 Door set-up, Learning and functional tests	13
3.6 Installation trouble-shooting	15
4 Functionalities	16
4.1 System	16
4.1.1 Working Modes	18
4.2 Connections	19
4.2.1 MLC signals connection	19
4.2.2 Direct connection of optical detector to the CDD 5.0	20
4.2.3 Connection of input signals from optional local contacts	20
4.3 HMI: front panel user interface	21
4.3.1 Display	21
4.3.2 HMI user interface description	22
4.4 External handset user interface	23
4.4.1 Functional description and keys usage	23
4.4.2 Handset menu-tree	24
4.5 Door Learning function	25
4.5.1 Standard Learning by HMI	25
4.5.2 Standard Learning by external Handset	25
4.5.3 Auto-set procedure: automatic learning function	26
4.6 Diagnostic Functions	27
4.6.1 Diagnostic operations by HMI	27
4.6.2 Diagnostic operations by Handset	28
4.7 Firmware upgrade function	29
5 Parameters	30
5.1 Door operator configuration Parameters	32
5.1.1 PC26: installed skate type	32
5.1.2 PC90: installed motor type	33
5.1.3 PC22: closing rotation sense	33

5.1.4	PC05: car door locking device settings	34
5.1.5	PC06: glass door settings	34
5.1.6	PC99: MLC interface logic settings	34
5.2	Speed profiles.....	36
5.2.1	P33: Pre-set Speed Profiles.....	36
5.3	Reversing management in closing direction	37
5.3.1	PC00: reversing events management.....	37
5.3.2	PC34: RVS output activation type.....	37
5.3.3	PC42: Closing force limit Auto-set	37
5.3.4	PC09: Closing force detection settings	38
5.3.5	Reversing Disabled offset at the end of closing	38
5.4	MLC interface management.....	39
5.4.1	PC01: MLC commands check mode.....	39
5.4.2	PC02: reaction of door drive if no MLC command	39
5.4.3	PC03: Alarm enabling if no MLC commands.....	39
5.5	Input signals management	40
5.5.1	PC04: RVC input function	40
5.5.2	PC21: reversing inputs logic settings	40
5.5.3	PC32: AUXC input function	41
5.5.4	PC27: RSC options.....	41
5.5.5	PC19: FFC options	42
5.5.6	PC20: EOD function time-out (based on EOC input)	42
5.6	Output signals management	42
5.6.1	PC07: AUXS output options	42
5.6.2	PC37: DOS output activation options	43
5.6.3	PC38: DOS output activation threshold.....	43
5.7	Door Closed parking management.....	44
5.7.1	PC25: Door Closed Parking mode	44
5.7.2	PC44: Door closed Reduced torque relaxing tolerance	45
5.7.3	PC45: Door closed Reduced torque activation delay	46
5.8	Particular Parameters.....	46
5.8.1	PC43: Door open parking with reduced torque.....	46
5.8.2	Reduced Speed value	46
5.8.3	Door Stopping space.....	47
5.8.4	PC24: "smooth" reopening.....	47
5.8.5	PC36: door opening maximum power option	47
5.9	Motor Thermal management.....	48
5.9.1	PC39: automatic opening speed profile reduction	49
5.9.2	Management of door blocked during opening.....	50
6	Maintenance	51
6.1	Alarms	51
6.2	Troubleshooting (FAQ)	53
6.3	Correct working check sequence	54
7	After sale	59
7.1	Customer support	59
7.2	Replacements.....	59
7.3	Material disposal.....	59
8	General information.....	60
8.1	General considerations	60

8.2	Confidentiality agreement	60
8.3	Safety.....	60
8.4	Installation personnel Requirements	61
8.5	User requirements	61
8.6	Standard and codes reference	61
8.7	Warranty	62
8.8	Final considerations	62
9	Annex	63
9.1	Product conformity declaration (DDC).....	63

Index of tables

- Table 1: door drive data	7
- Table 2: compatible motors data	7
- Table 3: system limits	7
- Table 4: list of connections/keys	9
- Table 5: mechanical installation of the drive –.....	11
- Table 6: installation of electrical parts –.....	13
- Table 7: configuration, learning and test sequence –	15
- Table 8: connections characteristics -	16
- Table 9: inputs types -	17
- Table 10: outputs types –	18
- Table 11: door drive working modes -.....	18
- Table 12: I/O signals connections vs MLC -.....	19
- Table 13: direct connection of the optical detector -	20
- Table 14: mean visualizations on the front panel display -	21
- Table 15: functional table of the CDD5.0 front panel -	22
- Table 16: functional table of the external diagnostic tool -	23
- Table 17: standard learning sequence by HMI -	25
- Table 18: auto-set learning procedure -	26
- Table 19: possible errors during auto-set learning procedure -	26
- Table 20: I/O signals reported -	28
- Table 21: measurements reported in the monitor menu table -	28
- Table 22: firmware upgrade sequence using usb Key -	29
- Table 23: parameter list of the CDD5.0 door drive -	31
- Table 24: main skate types -	32
- Table 25: selectable motor list -	33
- Table 26: CDD 5.0 alarms/warning list -	52
- Table 27: Trouble-shooting -	53
- Table 28: functional check sequence -	58

Introduction

The present user manual contains all the necessary information for a safe and correct installation, configuration, use and maintenance of the lift door controller CDD 5.0.

Before proceeding with the installation of the CDD 5.0, it is necessary and strongly recommended that the installation personnel have read and understood all the parts described in the present manual.



a non-correct installation of the system may cause serious danger and/or injury.

The present user manual is in any case integral part of the CDD 5.0 device, and it must be included to the installation documentation.

All the references to the safety and responsibility are reported in the chapter 8 “General information”.

The present manual contains detailed information related to the firmware version 02.00.000, regarding all descriptions about functional implementation.

NOTE: all the pictures, images, schematics reported in this manual have purely example purpose: the components of the lift system may result different, based on the installed motor and door operator.

Glossary

Symbol	Description	Notes
CDD 5.0	Computec Door Drive 5.0	
E.C.	Elevator Controller	
MLC	Main Lift Controller	
HMI	Human to Machine Interface	User Interface on the CDD5.0 front panel
DOC	Door Opening Command	Same as KA, VST-O
DCC	Door Closing Command	Same as KC, VST-S
RSC	Reduced Speed Command	Same as KB, VRVRT
RVC	Reversing Command	Same as KN
FFC	Fire-Fighting Command	Same as KFF
AUXC	Auxiliary Command	Same as KAUX
DTBC	Double TB Command	Same as K2TB
EOC	Emergency Opening Command	Same as KEOD
DETC	Detector (barriers, photocell) Command	Same as Det.In.
DOS	Door Opened Signal	Same as LA, KET-O
DCS	Door Closed Signal	Same as LC, KET-S
RVS	Door Reversing Signal	Same as IM, KSKB
AUXS	Auxiliary Signal	Same as AUX
BUZS	Acoustic Signal	Same as BUZZ, PIN21, AUX2
SL	Door Self-learning active	
Au	Auto-Setup procedure active	
CL	Closing/Closed	
OP	Opening/Opened	
FSET	Reversing force setting	
ms	Millisecond	
mA	milliAmpère	
Imp.	Space transducer pulses	
PSO	Parking with Skate Opened	
	Important Note	
S20	Aluminium Skate, 20mm space on the belt	
S90	Iron Skate, 90mm space on the belt	
S120	Iron Skate, 120mm space on the belt	

1 Technical Specifications

1.1 Standards and Codes References

All the references to the standards and Codes are reported in paragraph 8.6 “Standard and codes reference”.

1.2 Door Drive Data

Supply voltage	[100 ; 240]Vac 1-ph 50-60Hz, (115V – 20%, 230V + 30%)	Vac
Available Peak output power	300	VA
Nominal output power	200	VA
Working Temperature	[-10; +60]	°C
Humidity	[20;80] non condensing	%
Electrical protection	[5x20, 4A] rapid fuse on main power supply line [5x20, 8A] fuse on the battery supply line	
Environmental protection	IP-54 case	

- Table 1: door drive data

1.3 Compatible Motors Data

Motor type	Nominal power	Nominal voltage	Nominal Current
GR 63x25 + SG80K (15:1) + Enc100	50VA	24V	2.7A
GR 63x55 + SG120 (15:1) +Enc100	100VA	24V	4.9A
M63x50 + SN40 (15:1) + IGO100/2	100VA	24V	4.9A
M63x25 + SN31 (15:1) + IGO100/2	100VA	24V	2.7A
M48x60 + SN 22,6 (7:1) + IGO100/2	50VA	24V	1.5A
Moog 1Nm (4:1 belt) + Enc500	100VA	24V	2.7A
Moog 2Nm (4:1 belt) + Enc500	200VA	24V	1.5A

- Table 2: compatible motors data

1.4 System mechanical data

Motor type	Moving mass limit	Maximum Parking force available during parking with door opened	Maximum force available during closing movement
GR 63x25 + SG80K (15:1) + Enc100	180kg	70N	250N
GR 63x55 + SG120 (15:1) +Enc100	300kg	90N	270N
M63x50 + SN40 (15:1) + IGO100/2	300kg	85N	280N
M63x25 + SN31 (15:1) + IGO100/2	180kg	70N	240N
M48x60 + SN 22,6 (7:1) + IGO100/2	120kg	40N	200N
Moog 1Nm (4:1belt) + Enc500	180kg	150N	290N
Moog 2Nm (4:1 belt) + Enc500	300kg	150N	290N

- Table 3: system limits

2 Generalities

2.1 Intended use

The CDD 5.0 (Comptec Door Drive 5.0) device is an electronic system that permits to operate in practice all the lift door operated by the motors described in the table “- Table 2: compatible motors data”.

The CDD 5.0 controls the lift door opening and closing automatically, according to the commands received from the main lift controller of the lift system, and controls the time intervals, currents, speed profiles, different external devices directly pluggable to the drive, and the possible anomalous behaviour as over-voltages, connections interruptions, and so on.

2.2 System overview

The CDD 5.0 system is a part of the complete lift door operator, consisting in:

- Mechanical door operator:
 - o Header
 - o Carriages
 - o Belt
 - o Motor
- Door Drive (the CDD 5.0)
- Contacts Interface to the main lift controller

Following it is reported the connection diagram of the device:

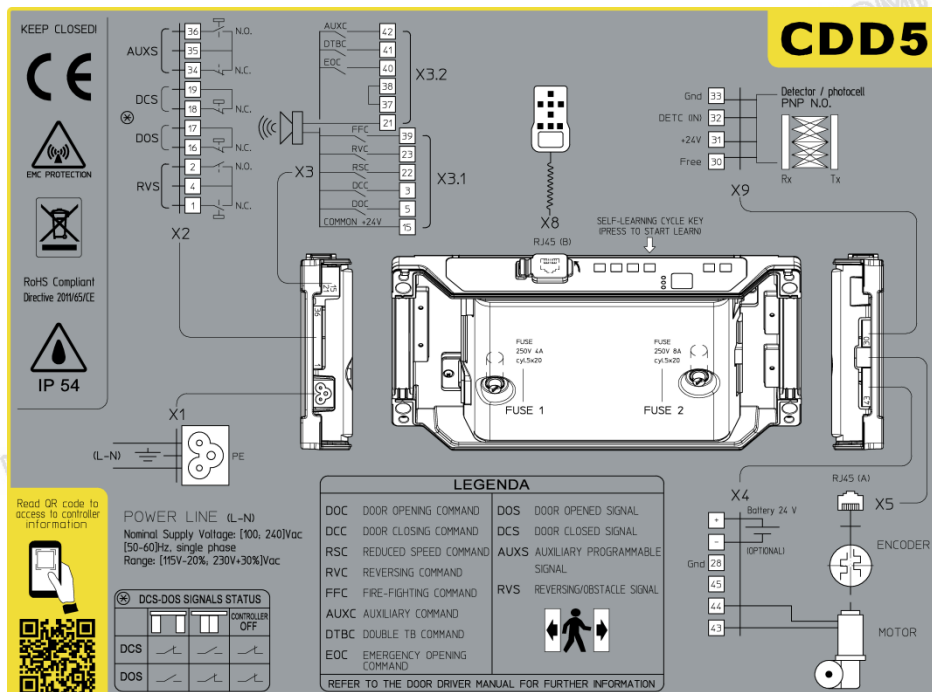

- Figure 2-1: connection diagram of the CDD 5.0

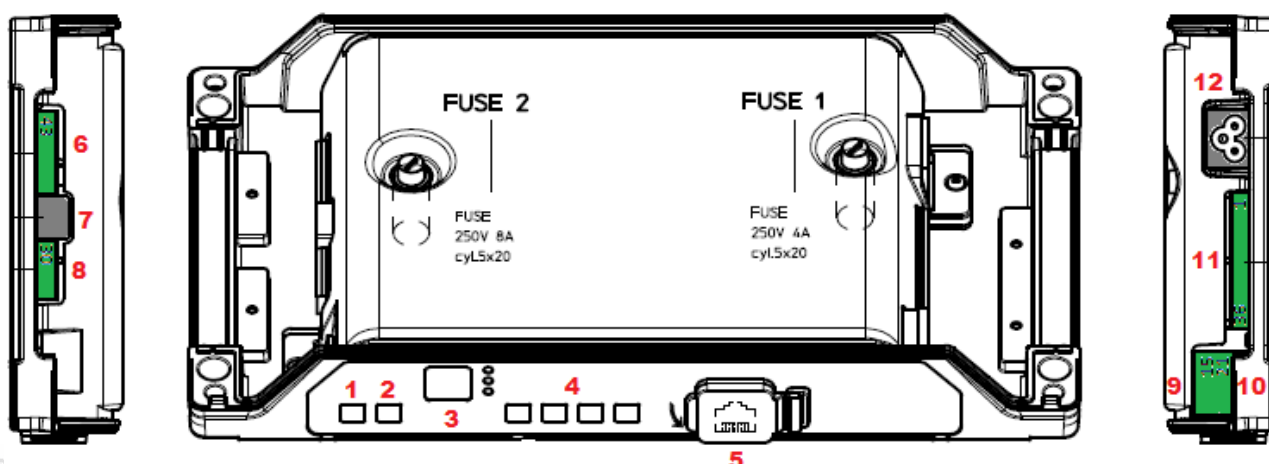

- Figure 2-2: identification of keys and connections

The controller is equipped with:

N°	ID	Description
1	ON	Power on key
2	OFF	Power off key
3	Display	7-segment display (two digits) to show status/configuration
4	"1" "2" "3" "4"	Functional keys for visualization/movement/programming
5	X8	Plug for upgrade/configuration external device
6	X4	Plug for motor/battery
7	X5	RJ45 plug for motor encoder
8	X9	Direct connection of optical light curtains (including power)
9	X3.1	Plug for Elevator controller commands
10	X3.2	Plug for local inputs of the door operator
11	X2	Plug for drive output to the elevator controller
12	X1	Plug for main power supply

- Table 4: list of connections/keys

2.3 Compatibility for applications and motors

The CDD 5.0 can be applied to all the lift door operators that use the motors reported in the compatibility table, in particular for that operator for which it is pre-set the configuration of the mechanical transmission (skate, motor pulley, ...).

It is possible in any case to adapt the system configuration to other door operator that uses the same motors, setting manually the specified parameters values. It is strongly suggested, in this case, to previously contact directly Computec technical support, for information about compatibility and configuration.

3 Installation

Before proceeding to the installation, verify the necessary safety devices:

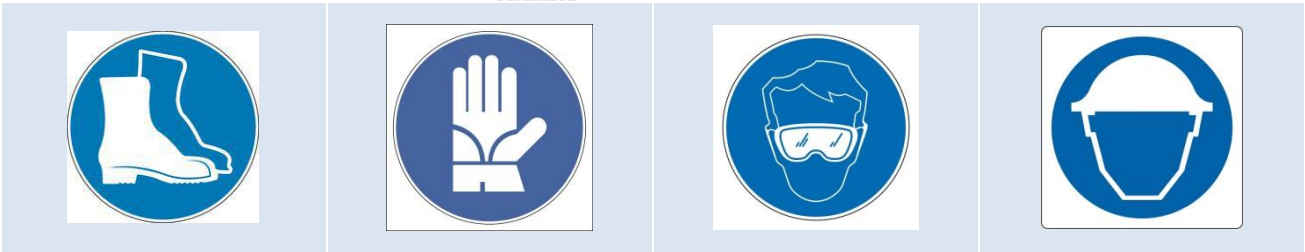

In addition verify the necessary instruments to perform all the operations:



Be sure to work in full safe conditions, setting the inspection mode on the lift before starting any operation.

3.1 Preliminary mechanical checks

The installation of the door drive has to be performed by expert technical personnel, having all the professional requirements expected, based on the active law in the installation country.

Before proceeding with the installation of the door drive it is necessary to:

- Check the correct and good status of the door operator installation:
 - o Correct installation of the door panels
 - o Correct installation of the carriages
 - o Correct installation of the transmission (belt connection, belt)
 - o Correct installation of the gear-motors, according to table “- Table 2: compatible motors data”
- Check that the panels movement is free, without obstacles overall the complete door space.
- Check the material of the box:
 - o CDD 5.0 door controller
 - o Retrofit fixation bracket to be fixed on the controller, in case of retrofit

3.2 Mechanical Installation

The mechanical installation of the door drive has to be executed according to the controller type to replace. For this reason the CDD 5.0 is supplied with the retrofit fixation bracket. The following table shows the two fixation possibilities.

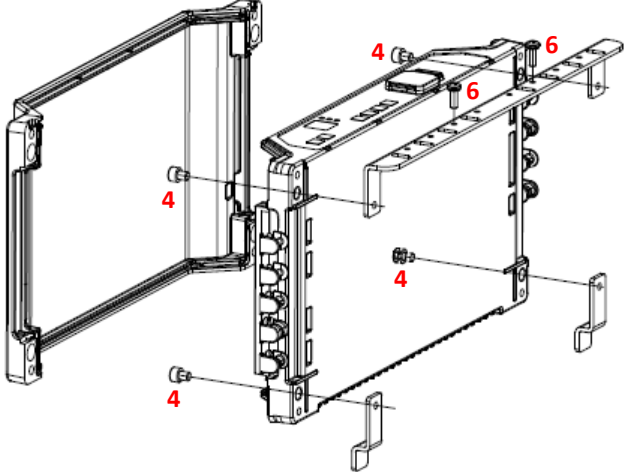
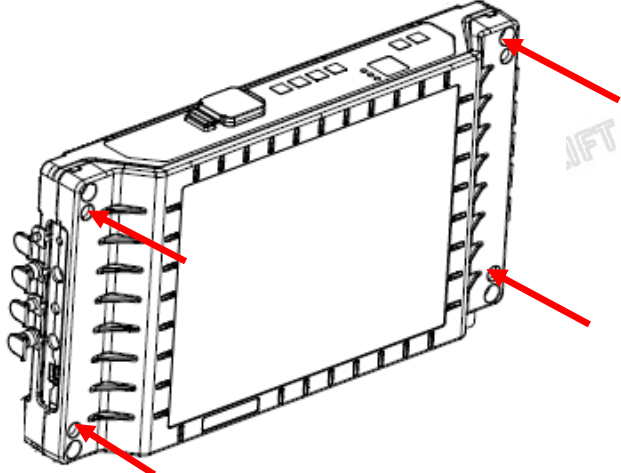
Fixation type	Description
<p>Installation with retrofit bracket</p> <ol style="list-style-type: none"> 1. Switch off the main power supply 2. Remove all the connection from the old door controller 3. Remove the door controller to be replaced 4. Remove the cover of the CDD 5.0. Apply the retrofit bracket to the CDD 5.0 5. Install the door controller, using the fixation holes aligned to the holes present on the operator. 6. Apply the previous fixation screws 	
<p>Installation on direct compatible systems</p> <ol style="list-style-type: none"> 1. Switch off the main power supply 2. Remove all the connection from the old door controller 3. Remove the door controller to be replaced 4. Remove the cover of the CDD 5.0 5. Apply the door drive using the four fixation points present on the operator. 	

- Table 5: mechanical installation of the drive -

3.3 Preliminary electrical checks

Verify the presence of the correct supply voltage, as reported in the table “- Table 1: door drive data”.

Once the mechanical installation of the CDD 5.0 drive is completed, and the CDD 5.0 is fixated to its holding (with retrofit bracket or directly), proceed as reported below.

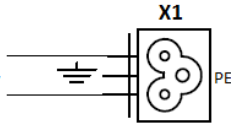



3	<p>Power supply connection</p> <p>Supply voltage: [115V – 20% ; 230V + 26%]Vac, 50-60Hz single phase</p> 
4	<p>Final Checks</p> <p>Verify that ALL the signals are connected, then apply the cover. For further information please refer to the paragraph 4.2</p>

- Table 6: installation of electrical parts –

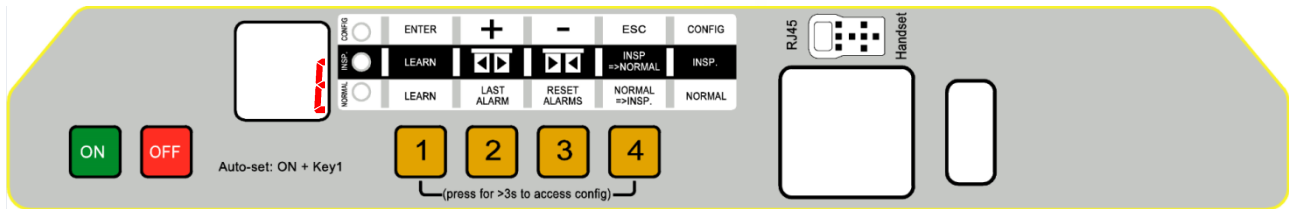

3.5 Door set-up, Learning and functional tests

Once the physical installation phase described in the previous paragraph is completed, it is possible to proceed with the power on of the device and its configuration. In case of problems during the execution of the phases, please refer to the paragraph 6.2. Refer to paragraph 4.3.2 for the front panel use.



STEP	Operation	Description	Notes										
1	Power supply test	<p>Connect the main power supply.</p> <p>Press  button on the door drive front panel</p>											
2	Door operator configuration	<p>Configure the parameters related to the installed door operator (please refer to paragraph 5.1):</p> <table border="1" style="width: 100%;"> <tr> <td>P05</td> <td>Car door locking device (0=not present, 1=present)</td> </tr> <tr> <td>P22</td> <td>Motor Closing rotation (0=clockwise,1=counter-clockwise)</td> </tr> <tr> <td>P26</td> <td>Skate type (0=S20, 1=S90, 2=S120)</td> </tr> <tr> <td>P90</td> <td>Installed motor type (00=self-recognized)</td> </tr> <tr> <td>P99</td> <td>MLC commands logic (0=H active and RSC forced closing, 1=L active and RSC reduced speed, 2=H active and RSC reduced speed)</td> </tr> </table>	P05	Car door locking device (0=not present, 1=present)	P22	Motor Closing rotation (0=clockwise,1=counter-clockwise)	P26	Skate type (0=S20, 1=S90, 2=S120)	P90	Installed motor type (00=self-recognized)	P99	MLC commands logic (0=H active and RSC forced closing, 1=L active and RSC reduced speed, 2=H active and RSC reduced speed)	Refer to paragraph 4.3.2 for the information about access to Configuration Mode.
P05	Car door locking device (0=not present, 1=present)												
P22	Motor Closing rotation (0=clockwise,1=counter-clockwise)												
P26	Skate type (0=S20, 1=S90, 2=S120)												
P90	Installed motor type (00=self-recognized)												
P99	MLC commands logic (0=H active and RSC forced closing, 1=L active and RSC reduced speed, 2=H active and RSC reduced speed)												
3	Self-learning execution	<p>Enter in the Door Drive Inspection mode, pressing key  and check that INSP led is on.</p> <p>Press and keep pressed key  and check the door closing with reduced speed, if not closed. The door completes the panels and skate closing.</p> <p>Release key .</p> <p>In case the movement direction is wrong or in case of alarms, proceed with the checks suggested in the paragraph 6.2.</p>	<p>Display visualization:</p>  INSP led ON <p>"CL" blinking "CL" fixed</p>										

		<p>To optimize the execution of the learning procedure, it is suggested to couple car and landing door, executing the operations from the car roof in inspection mode.</p> <p>Press key 1 for at least 1s to enable Self-Learning.</p> <p>Press shortly key 2. The door starts opening with reduced speed until the door is completely opened.</p> <p>The learning phase is completed.</p>	<p>"SL" fixed</p> <p>"SL" blinking</p> <p>"OP" fixed</p>
<p>4</p>	<p>Speed Profiles check in Inspection mode</p>	<p>Press continuously key 3 to execute the door closing with normal speed, until the door is completely closed.</p> <p>Press continuously key 2 to execute the door opening with normal speed, until the door is completely opened.</p> <p>In case it is necessary to tune the speed profiles, please refer to the paragraph 5.2.1</p>	<p>Display visualization:</p> <p>"CL" blinking</p> <p>"CL" fixed</p> <p>"OP" blinking</p> <p>"OP" fixed</p>
<p>5</p>	<p>Obstacle reversing check in Inspection mode</p>	<p>Put an obstacle at different points of the door access.</p> <p>Press and keep pressed key 3 to perform a door closing.</p> <p>When the panels meet the obstacle, the door drive will immediately reverse the movement starting the reopening.</p> <p>Release key 3 during the reopening movement and wait until the door is completely opened.</p>	<p>Display visualization:</p> <p>"CL" blinking</p> <p>"IM" blinking</p> <p>"OP" fixed or "- " blinking</p>

<p>6</p>	<p>Detector check in Normal mode</p>	<p>Execute this step only if external optical detector, light curtains or photocell are directly connected to the CDD 5.0, to the RVC input or to the X9 plug.</p> <p>Activate the normal mode of the door drive, from the Inspection mode, by pressing key 4 and check the NORMAL led is ON.</p> <p>During the door closing, interrupt the light curtains and check the immediate reopening of the door, until the door is completely open.</p> <p>Remove any obstacle from the detector activation zone, and check the door closing until the door is completely closed.</p>	<p>Display visualization:</p>  <p>NORMAL led ON</p> <p>“CL” blinking “IM” blinking. “IM” fixed.</p> <p>“CL” blinking “CL” fixed</p>
<p>7</p>	<p>Functional check in Normal mode</p>	<p>Complete the door closing, if not performed: press and keep pressed key 3 until the door is completely closed.</p> <p>Release key 3.</p> <p>Check the closing force limit for reversing, with appropriate instrumentation.</p> <p>Activate the NORMAL mode of the controller, from the Inspection mode: press key 4 and check the led NORMAL is on.</p> <p>Now the controller works in Normal mode, and executes the commands received from the MLC, as well as the reversing from detector directly connected to the door controller.</p> <p>Perform all the functional checks with the complete system operating in Normal mode, from the car roof or from the landing, according to the procedure active for the involved maintenance people.</p>	<p>Display visualization:</p>  <p>led NORMAL on</p>

- Table 7: configuration, learning and test sequence -

3.6 Installation trouble-shooting

The installation sequence previously reported describes all the steps that have to be executed to operate a correct and complete set-up of the door system.

In case of issues, or if anomalous behaviours happen during the installation, please refer to the paragraph 6.2 “Troubleshooting (FAQ)”. For any alarms, please refer to the paragraph 6.1 “Alarms”.

4 Functionalities

The present chapter describes in details the structure and the functionalities of the CDD 5.0 system.

4.1 System

The CDD5.0 lift door drive is a part of the lift door operator. Refer to the paragraph 2.2 for the description of the different parts of the system. Refer to the paragraph 1.3 for the details about the compatible motors that can be controlled by the CDD5.

Following it is reported the connection diagram of the device:

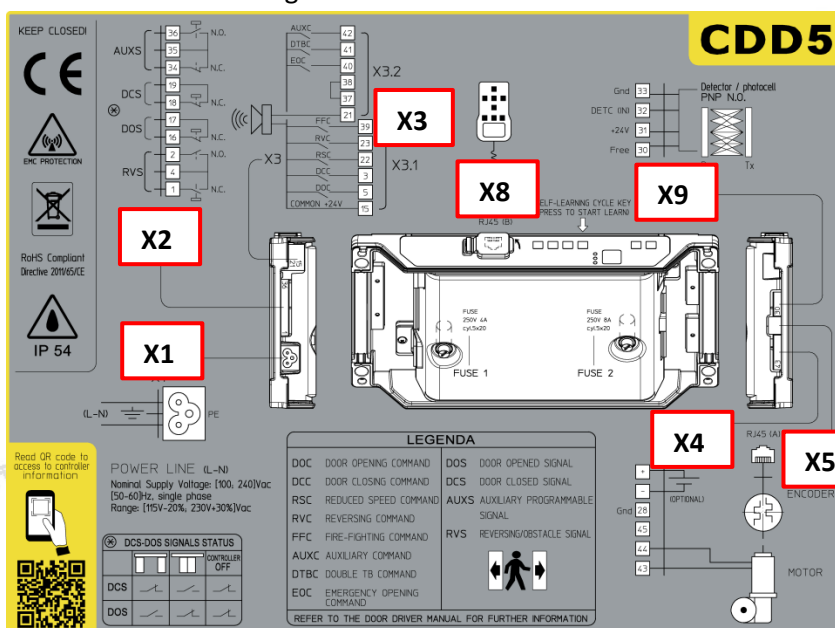

- Figure 4-1: connection diagram of the CDD 5.0 -

The connection details for every available plugs are reported below:

Terminal N°	Connection mode	Connection type	Conductor type	Temperature range	Fixation torque	AWG UL/CL section
X4	Screw	Load (motor output power)	Use only copper conductor	60°C (140°F)	Min 0.5 Nm Max 0.6 Nm	Min 20 Max 18
X5	Plug	Motor Encoder	Use only copper conductor	Not required	Not required	Not required
X9	Screw	Optical Detector	Use only copper conductor	Not required	Min 0.5 Nm Max 0.6 Nm	Min 30 Max 12
X3.1	Screw	MLC commands	Use only copper conductor	Not required	Min 0.5 Nm Max 0.6 Nm	Min 30 Max 14
X3.2	Screw			Not required		Min 30 Max 12
X2	Screw	Outputs to MLC	Use only copper conductor	Not required	Min 0.5 Nm Max 0.6 Nm	Min 30 Max 12
X1	Insertion	Main power supply	Flexible cable according to UL ZICZ category.	60°C (140°F)	Not required	Min 18 Max 12
X8	Insertion	Handset/ Upgrade key	-	Not required	-	-

- Table 8: connections characteristics -

The following table reports all the INPUTS available on the controller:

Signal	Position	Description	Contact type	Default status	Notes
DOC	X3.1.5	Door Opening Command (from MLC)	Dry contact	Open	
DCC	X3.1.3	Door Closing Command (from MLC)	Dry contact	Open	
RSC	X3.1.22	Forced reduced speed closing command or Reduced speed enable command (from MLC)	Dry contact	Open	The MLC may activate this command when the light curtains (connected to MLC) are deactivated from the MLC, after a timeout or maximum closing retries
RVC	X3.1.23	Reversing external source	Dry contact	Open	
FFC	X3.2.39	Fire-Fighting mode enable command (from MLC)	Dry contact	Open	
DTBC	X3.2.41	Second TB floor input command	Dry contact	Open	This contact is installed on the floor with a different opening space. It is necessary to execute a second door learning during installation phase
AUXC	X3.2.42	Auxiliary contact (programmable)	Dry contact	Open	
EOC	X3.2.40	Evacuation floor contact	Dry contact	Open	This contact is installed at the evacuation floor to permit the automatic opening cycle with drive powered by batteries

- Table 9: inputs types -

The following table reports all the OUTPUTS available on the controller:

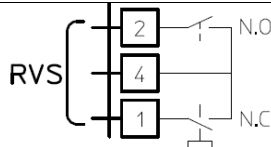
Signal	Position	Description	Contact type	Default status	Notes
DOS	X2.16 X2.17	Door Opened signal (to MLC)	Dry contact	Closed	Contact open when the door is completely opened. Ratings: 3A 250Vac 30Vdc
DCS	X2.18 X2.19	Door Closed Signal (to MLC)	Dry contact	Closed	Contact open when the door is completely closed. Ratings: 3A 250Vac 30Vdc
RVS	X2.1 X2.2 X2.4	Reversing source active or reversing movement active (to MLC)	Dry contact	Double contact	 <p>This contact switches, closing the N.O. contact on the common voltage, when an obstacle is present (from internal closing force limiter or from external sources) Ratings: 3A 250Vac 30Vdc</p>

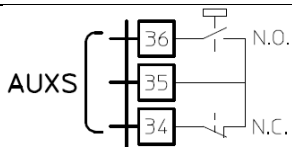
AUXS	X2.34 X2.35 X2.36	Auxiliary signal (to MLC)	Dry contact	Double contact	 <p>AUXS</p> <p>Programmable functions Ratings: 3A 250Vac 30Vdc</p>
Acoustic signal	X3.2.21	Acoustic signal	Open collector 100mA	Open	Activates the acoustic signal in different condition, based on the settings of different parameters

- Table 10: outputs types -

4.1.1 Working Modes

The CDD 5.0 door drive can activate the following working modes:

MODE	DESCRIPTION
NORMAL	This is the normal automatic working mode. The door drive after the power on enters in this working mode. In this working mode the controller executes the movements requested from the commands sent by the MLC.
INSPECTION	This is the Inspection mode of the door drive. In this working mode the door drive does not accept commands from MLC, but executes the opening/closing movements according to the pressure of "<>" and "><" buttons on the door drive front panel. ATTENTION: in this working mode the external reversing sources are disabled.
CONFIGURATION	This is the programming mode, where it is possible to configure and set all the parameters accessible front the door drive front panel.
DIAGNOSTIC	The controller enters in this working mode, when a recognized device is connected to the X8 plug. The door drive recognizes the connection of the external device and, from any of the previous working mode, enters in this one. In this working mode, the controller communicates with the external device for all the diagnostic/configuration/monitor/upgrade operations. When the external device is disconnected, the controller returns automatically in Normal mode.
UPGRADE	This is the mode in which the controller enters during the firmware upgrade.

- Table 11: door drive working modes -

Please refer to paragraph 4.3 "HMI: front panel user interface" about the use of the door drive front panel, and how to move from one to another working mode.

4.2 Connections

4.2.1 MLC signals connection

The present paragraph reports the connections between door drive and MLC, focusing the attention on the connection for the common voltage to use, in case it is the common voltage from door drive (24_DD) or from MLC (24_EC). The door drive has a 24Vdc auxiliary common voltage for the wiring of commands, with maximum load limit current of 1A.

Common Voltage	Connection	Notes
24V_DD		<p>The 37-38 bridge must be present. The MLC uses the 24Vdc from the door drive as common voltage for commands and door drive outputs.</p> <p>Commands: DOC, DCC, RSC, FFC. As example only the first two are reported in the diagram: the others follows the same connection rules.</p> <p>The door drive outputs, being dry contacts, can be connected to another common voltage, if requested by the MLC.</p> <p>The door drive outputs have a dedicated common voltage available for each output. In the diagram they have been grouped in a single pin, that represents a series of bridges between X2.4, X2.16, X2.18, X2.35</p>
24V_EC		<p>Remove the 37-38 bridge and connect the external 0V from MLC to the 38 pin. Commands: DOC, DCC, RSC, FFC. As example only the first two are reported in the diagram: the others follows the same connection rules.</p> <p>If local wired contacts are present:</p> <ol style="list-style-type: none"> 1. use the same common voltage active for the commands. 2. use the auxiliary 24Vdc of the door drive, recovering the 37-38 bridges. In this case check the compatibility between 0V_DD and 0V_EC. <p>The door drive outputs keep the same common voltage from MLC, used for the commands.</p> <p>The door drive outputs have a dedicated common voltage available for each output. In the diagram they have been grouped in a single pin, that represents a series of bridges between X2.4, X2.16, X2.18, X2.35</p>

- Table 12: I/O signals connections vs MLC -

4.2.2 Direct connection of optical detector to the CDD 5.0

The present paragraph illustrates the connection of the external reversing sources (detector, light curtains, photocells) directly to the door drive, both as dry contacts or as devices that need also supply voltage.

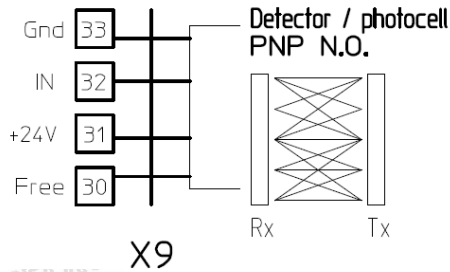

The X9 plug permits to directly connect a PNP device (N.O. or N.C.) to the CDD 5.0: the door drive gives the supply voltage for the device, as reported in the following table:

PIN	DESCRIPTION	NOTES
33	GND	0V pin
32	DETC (IN)	Input pin: connect the status pin of the PNP N.O. or N.C. detector
31	+24Vdc	Voltage supply pin: 24Vdc, 100mA max
30	Free	Free pin: it may be used to fix the connection between RX and TX parts of the detector

- Table 13: direct connection of the optical detector -

NOTE: if it is necessary to connect a detector with N.C. output, reverse the input signal polarity by the parameter described in the paragraph 5.5.2 "PC21: reversing inputs logic settings".

NOTE: if it is necessary to connect a NPN detector, please contact Technical support per the dedicated instructions.

4.2.3 Connection of input signals from optional local contacts

The present paragraph describes how to connect to the door drive the signals from the special local contacts: EOC, DTBC AUXC.

In this case a magnetic switch is normally installed on the door operator (car side), while on the floor side it is installed a support plate with two magnets that permits the commutations of the magnetic switch, that will be active only when the car is between the two magnets (car at the floor).

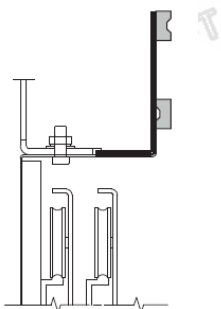

The magnetic switch should be then connected to the desired pin of the door drive. Refer to the paragraphs related to the different functions, for the specific descriptions.

4.3 HMI: front panel user interface

The CDD 5.0 door drive has a front panel that permits to activate different working modes: Normal, Inspection and Configuration.

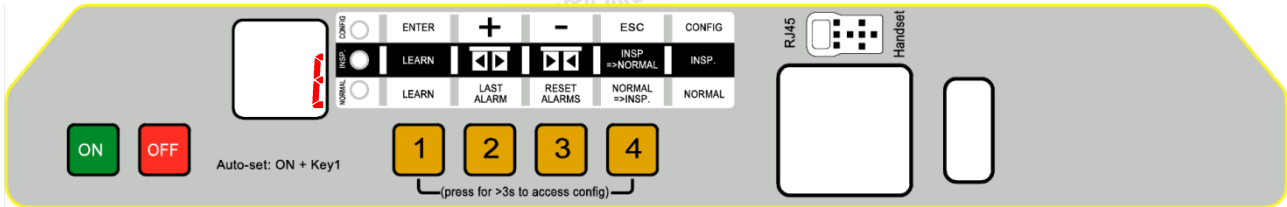

- Figure 4-2: front panel of the CDD5.0 door drive -

4.3.1 Display

The display (7-segment, two digits) present on the front panel permits the direct visualization of the drive status and the current configurations, based on the active working mode. the following table reports the main possible visualizations:

Digits	Description
OP	Blinking: OPENING in progress Fixed: Door OPENED
CL	Blinking: CLOSING in progress Fixed: Door CLOSED
AU	The controller auto-set procedure is in progress
Er	During the auto-set procedure an error occurred, the procedure has been interrupted and it must be restarted.
SL	Blinking: door Self-learning active but not in progress Fixed: Self-learning opening movement in progress
FC	Blinking: forced closing with reduced speed is in progress
AL	Alarm active, alternate to the alarm code.
IN	Blinking: reversing movement in progress Fixed: an external reversing source is active, with door opened.
--	This means all the following: - the door drive is waiting for a command - the door panels are at intermediate position (not opened and not closed) - the door drive is not receiving any command from the elevator controller

- Table 14: mean visualizations on the front panel display -

4.3.2 HMI user interface description

The CDD 5.0 door drive has a front panel that allows to activate different functional modes: Normal, Inspection, Configuration.

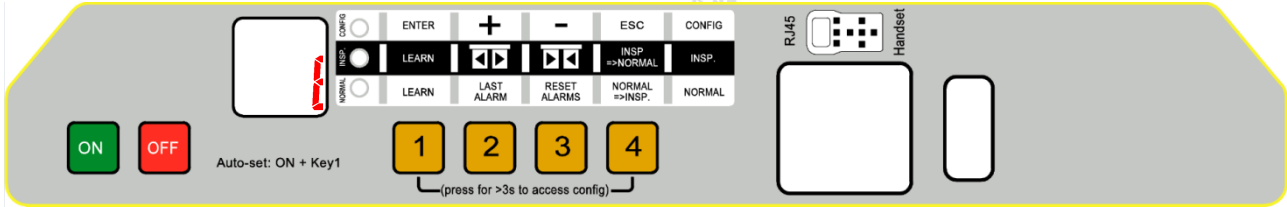

MODE		NORMAL	INSPECTION	CONFIGURATION
Description		Normal mode (automatic): the door drive executes the commands from MLC	Inspection mode (manual): the door drive executes commands from the front panel keys	Configuration mode: parameters Programming
LEDS	NORMAL	ON	OFF	OFF
	INSP	OFF	ON	OFF
	CONFIG	OFF	OFF	ON
KEYS	1	Only Key 1 pressed for t>1s: Self-learning activation Key 1 and key 4 pressed together per t>3s: Configuration mode access	Only Key 1 pressed for t>1s: Self-learning activation	Enter Access to parameter value OR Parameter value saving and return to parameters list
	2	Pressed and keep pressed (t>3s): Last alarm code showed ("no AL" if no alarm present)	Door opening	+ Increase Parameter index, OR Increase Parameter value
	3	Pressed for t>3s: reset of the last alarm codes ("dL AL"). Key 2 and key 3 pressed together for t>3s: Speed profiles reset	Door closing	- Decrease Parameter index, OR Decrease Parameter value
	4	Access to Inspection mode (if only key 4 pressed for t<1s) Access to Configuration mode (if Key 1 and key 4 pressed together for t>3s)	Return to Normal mode	Esc Exit from parameter selection OR Exit from Configuration mode and return to Normal mode
DISPLAY		Door drive status showed: "--", "OP", "CL", "IM", "AL", ..	Door drive status showed: "--", "OP", "CL", "IM", "AL", ..	Parameter list: "P" alternate to the parameter index. Parameter modification: parameter value showed
NOTES		This is the default mode at the power on of the door drive. ALL inputs are active	ALL the signal from the MLC are not active	Parameter selection: "P" showed alternate to the parameter index

- Table 15: functional table of the CDD5.0 front panel -

4.4 External handset user interface



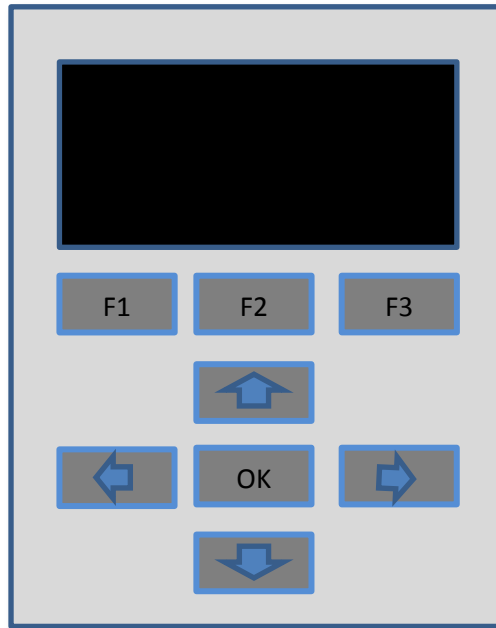

The CDD 5.0 door drive can be connected with some of diagnostic and configuration tools, currently available on the market.

4.4.1 Functional description and keys usage

In this paragraph the keys function are reported, for a proper use of the diagnostic/configuration tool.

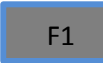
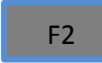
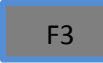

- Figure 4-3: Diagnostic/Programming tool example -

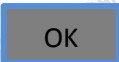
KEY	DESCRIPTION
  	The F1 F2 and F3 keys have different function, based on the current “menu”. In any case the key function is reported on the display above each key.
	In the selection list menu, scroll the list from bottom to top. In the parameter change menu, permits to increase the parameter value.
	In the selection list menu, scroll the list from top to bottom. In the parameter change menu, permits to decrease the parameter value.
 	in some menus it permits to select parameter organized in particular parameter tables.
	In the list menu, access to the selected (highlighted) voice. In the selection menus, access to the parameter to change and to save the set value.

- Table 16: functional table of the external diagnostic tool -

4.4.2 Handset menu-tree

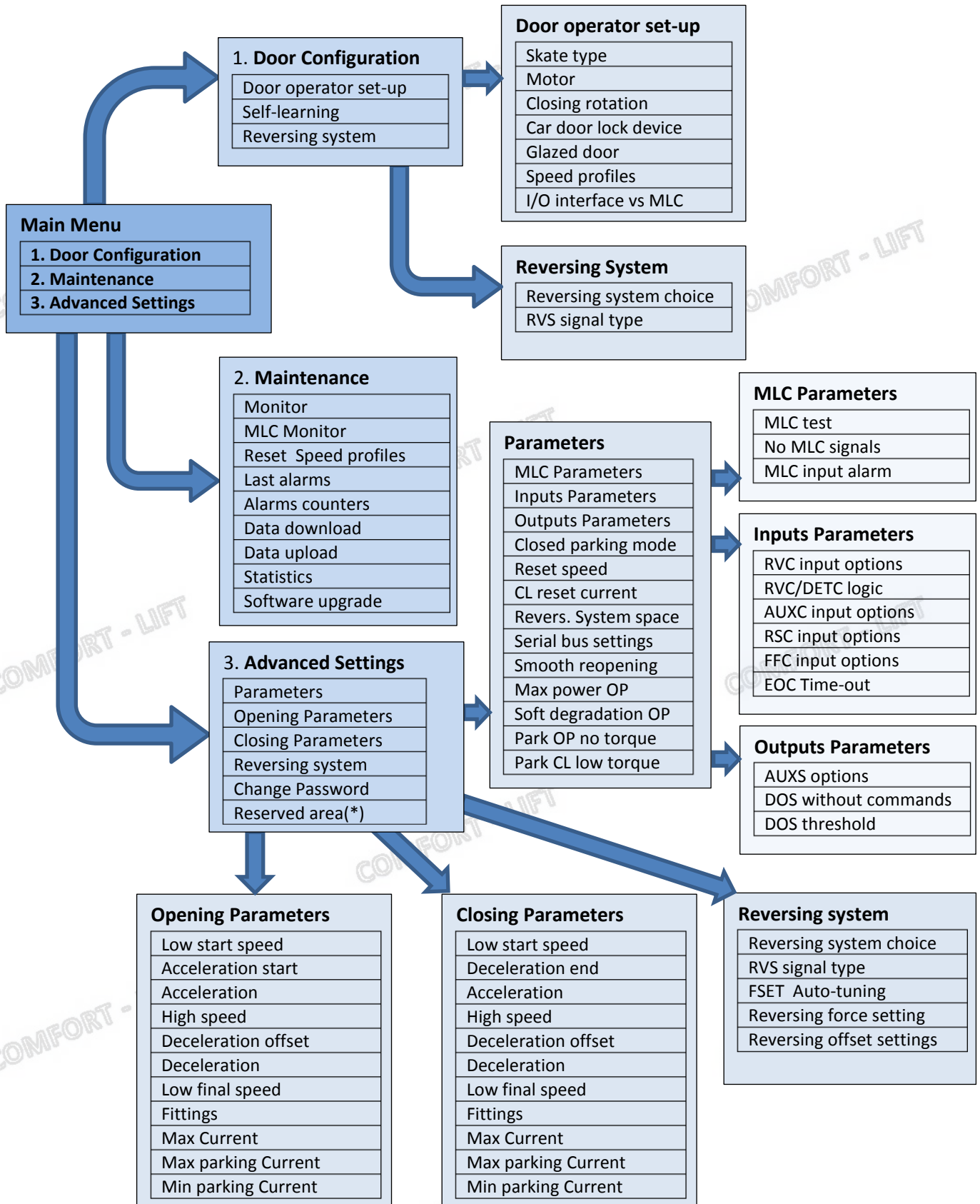

(*): available only for manufacturer

4.5 Door Learning function

The door learning function is the basic fundamental operation to be performed, to obtain a correct behaviour of the system. The CDD 5.0 controller can perform two different door learning procedures:

1. Standard Learning
 - This procedure permits to learn the door space, from door closed (and clutch closed) position, to door open position. It can be started directly from the door drive front panel, or by external device. Before starting the learning procedure, be sure to have pre-set all the parameters that identify the door operator (PC05 car door lock, PC26 skate type, PC22 closing rotation, PC90 motor type, PC99 MLC interface).
2. Automatic learning
 - This procedure permits to learn automatically: the door space, the exact skate space measured on the belt (the skate type too) and the closing rotation. Before starting the learning procedure, be sure to have pre-set all the other parameters that identify the door operator (PC05 car door lock, PC90 motor type, PC99 MLC interface). The auto-set procedure allows an optimal tuning of the controller interfaced to the door operator.

NOTE: please refer to chapter 5, for the parameter list and set-up

4.5.1 Standard Learning by HMI

The standard learning by HMI can be performed following the sequence reported in the table below:

Sequence	Notes
Controller power on	After main power supply is connected, press key 1
Door operator parameters configuration	Configure PC05, PC22, PC26, PC90, PC99 according to the installed door operator
Inspection Mode Activation	Press key 4 and check INSP led is on
Door closing	Press continuously key 3, until the door is completely closed, checking that the display shows "CL" fixed
Learning mode activation	Press key 1 for at least 1s, and check that the display shows "SL"
Learning opening cycle activation	Press shortly key 2, until the door starts to open with reduced speed, and the display shows "SL" blinking. When the door is completely opened, the display visualisation switch from "SL" blinking to "OP" fixed. The learning procedure is completed

- Table 17: standard learning sequence by HMI -

4.5.2 Standard Learning by external Handset

The standard learning by external handset can be executed simply accessing to the " Self-learning" menu:

Main Menu → Door Configuration → Self-Learning

It is always suggested to execute a complete closing movement, before activating the learning procedure.

4.5.3 Auto-set procedure: automatic learning function

This feature allows to automatically learn:

1. Installed motor type
2. Closing rotation
3. Actual skate space
4. Door space

Execution:

STEP	Action	Result / Checks
1	Align car and landing door	Check alignment
2	Switch off door drive by pressing OFF key	Check the door drive is OFF
3	 Set manually the door position at closed panels and skate opened	Check the correct panels closed position. This position represents the starting point for the skate space measurement
4	Press and keep pressed key 1, and press ON key	Keep pressed key 1, until the door drive front panel display shows "Au"
5	Wait	The door moves shortly in both directions to acquire information
6	Wait	The door will completely closed the door and the clutch with reduced speed.
7	Wait	The door will completely open with reduced speed and the display visualization switch from "Au" to "Op". The Auto-set procedure is completed

- Table 18: auto-set learning procedure -

In case the procedure ends before it is completed, check the display to have information about the possible errors:

Display	Error	Solution
AL + alarm code	An alarm occurred during auto-set procedure	Refer to alarms table (paragraph 6.1 "Alarms") and to the related solutions. AL04: wrong motor cables connection AL05: wrong or not present encoder connection AL07: motor cables not connected
Er	The starting panels position is not correct	Repeat the procedure focusing the attention to the panels closed and skate opened position
	The measured skate space is out of the acceptability range [1 ; 150]mm	Check the installed skate. In case of skate not present, check the starting position.
	Obstacles and/or frictions are present and does not allow the door movement.	Remove any possible obstacle and friction

- Table 19: possible errors during auto-set learning procedure -



IMPORTANT: in case auto-set procedure completes correctly, but the resulting speed profiles show any anomalous behaviour near the panels closed position, repeat the procedure **paying attention to the initial panel position, that must be CLOSED (that means no gap between panels) and the skate MUST be COMPLETELY OPENED.**

4.6 Diagnostic Functions

4.6.1 Diagnostic operations by HMI

The diagnostic operations allowed by door drive front panel are limited, but permit to execute some basic functions as described below.

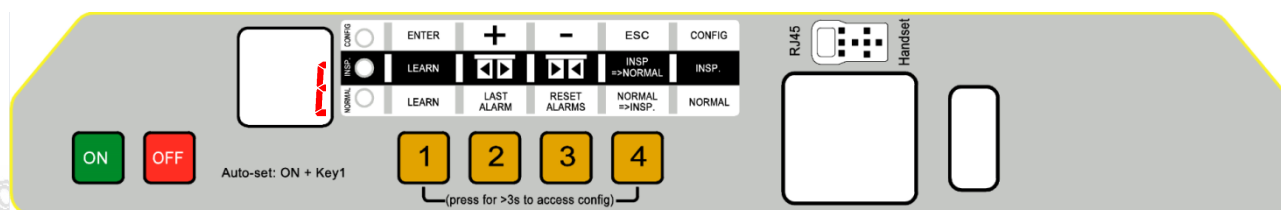

- Figure 4-4: CDD 5.0 front panel -

4.6.1.1 Profiles check in Inspection Mode

It is possible to verify the correct opening and closing of the door, activating the Inspection Mode from the front panel (pressing key 4, until INSP led is on). In this mode it is possible to check:

- Correct setting of the closing rotation (pressing key 2 or 3 and checking opening and closing accordingly)
- Correct execution of the normal speed profiles
- Correct setting of the door opened and door closed, checking the feedback from the display that shows “oP” and “CL” blinking and becomes fixed when movement is completed.

4.6.1.2 Alarm code reading and alarms reset in Normal Mode

It is possible to read the last warning/alarm code activated by the door drive keeping pressed the “2” button on the drive front panel, when the drive is in Normal mode.

4.6.1.3 Default Speed Profiles in Normal Mode

It is possible to apply the default values for the speed profiles, to recover the door drive to the factory settings, in case of wrong behaviour after different parameters change.

Press key 2 and 3 together for at least 3s. the CDD 5.0 then proceed to the application of the default speed profiles and performs an automatic restart.

4.6.2 Diagnostic operations by Handset

The external handset permits to perform a deep diagnostic of the door controller:

- Check of ALL the settings
- Speed profiles check
- Drive readings check
- Check of ALL I/O

4.6.2.1 I/O diagnostic

Access to “Main Menu ” → “Maintenance” → “MLC Monitor” and check the status of ALL inputs and outputs of the door drive. When the signal is active, the correspondent signal description results highlighted.



ATTENTION: in this menu the controller returns in Normal mode, and executes all the commands coming from the Main Lift Controller.

The following table shows the I/O visualization:

INPUTS		OUTPUTS
DOC	EOC	DOS
DCC	DTBC	DCS
RSC	AUXC	RVS
RVC	DETC	AUXS
FFC		BUZS

- Table 20: I/O signals reported -

4.6.2.2 Profiles and measurements checks

Access to: “Main Menu” → “Maintenance” → “Monitor”. The “Monitor” menu permits to check the speed profiles (speed reported in m/s), output power (in W) and output force (in N). By pressing OK button, it is possible to access to the measurements table as reported below:

MEASUREMENTS					
Column 1			Column 2		
Symbol	Units		Symbol	Units	
O	ms	Last panels opening time (even if partial reopening)	D	mm	Learned door space (including clutch movement)
C	ms	Last panels closing time (even if partial reopening)	S	mm	Actual door position
E	imp	Encoder pulses (speed transducer) counter status	T	°C	Estimated motor temperature
I	mA	Instantaneous motor current	F	N	Actual Closing force limit
B	%	% of battery charge (0=battery not connected)	G	-	-

- Table 21: measurements reported in the monitor menu table -

NOTE: the space measurements are calculated based on the encoder mounted on the motor. The absolute precision is then influenced by all the transmission system tolerances.

4.7 Firmware upgrade function

The CDD5.0 door drive firmware can be upgraded, in case new versions are available, using a special usb stick (refer to paragraph 7.2), that presents two access sides:

- Computer access side: USB connector
 - The stick can be connected to any PC that has usb ports: the stick is recognized by the PC as a mass storage device. Copy the version to be installed on the usb stick and proceed with the normal operations to remove the stick from the PC.
 - Check that usb stick contains only the version to be installed. In case of multiple versions, the more recent one will be installed.
- Door drive access side: RJ45 connector
 - Connect the stick to the door drive, into the X8 plug. Proceed the with the upgrading sequence reported in the following table.

STEP	Description	Stick LEDS Visualization	CDD Display	Notes
0	Door drive power off	Off	Off	Press OFF key on the CDD 5.0 front panel
1	Insert usb stick into X8	Off	Off	
2	Door drive power on	All leds blinking	"- -"	Press ON key on the CDD 5.0 front panel Initialization phase: - communication between stick and door drive - data acquisition from the door drive - check of available file, compatible with the connected door drive if this checks are successfully completed the usb stick sets the programming mode on the door drive → go to step4 if any error happened → step3
3	Initialization error	RED Led on	"- -"	An error happened during initialization phase: - there is no communication between stick and door drive Or - the stick has not saved any file compatible with the connected door drive Or - the connected door drive is not compatible with the stick Remove the usb key, check the files and retry
4	Restart request	YELLOW Led blinking	"- -"	Switch off the door drive by pressing OFF key. Switch on the door drive by pressing ON key. → step5
5	Initialization	All leds blinking	Off	Communication initialization in programming mode. → step6
6	Firmware upgrade	GREEN Led blinking	Off	New firmware download in progress from the usb stick to the door drive memory. if the download is completed correctly → step8 if any error occurred → step7
7	Firmware upgrade failed	RED Led on	Off	The upgrade has failed. The door drive remains in programming mode. Switch off and on the controller, keeping the usb key connected; then return to step5.
8	Firmware upgrade completed	GREEN Led on	"- -"	The firmware upgrade has completed successfully. Remove the usb key. Switch off and on the door drive and then check the controller behaviour.

- Table 22: firmware upgrade sequence using usb Key -

Verify on the web site "www.computeelectronics.it" any available new firmware versions.

5 Parameters

The CDD5.0 door drive can be configured by a parameters set, most of them are accessible also from the door drive front panel. The following table reports all the parameters that can be changed by the door drive front panel. The associated functions are described in detail in the next paragraphs. **The parameters highlighted in the table represents the key parameter for the door operator configuration.**

N°	RANGE	DEFAULT	Name	Values Description
00	[0 ; 2]	0	Reversing events management	00 = internal 01 = external when moving 02 = external, moving + parking
01	[0 ; 2]	0	MLC commands check	00 = level. 01 = level, also when parking. 02 = activation edge
02	[0 ; 2]	0	Door drive reaction on MLC commands not present	00 = instant stop 01 = low speed + stop 02 = low speed cycle
03	[0 ; 1]	0	No MLC signal alarm	00 = disabled 01 = enabled
04	[0 ; 2]	0	RVC input option	00 = reversing on RVC edge 01 = reversing on RVC active level 02 = mechanical safety edge
05	[0 ; 1]	0	Car door locking device	00 = car door lock not present 01 = car door lock present
06	[0 ; 1]	0	Glazed door	00 = not present 01 = present
07	[0 ; 3]	3	AUXS output options	00 = disabled 01 = active during door opening 02 = active after space % reached 03 = Alarm signal
08	[0 ; 99]	50	Space percentage (related to PC07=2)	00 = door closed ... 99 = door opened
09	[0 ; 99]	65	Closing force limit	00 = 100N ... 99 = 150N (based on the motor)
10	[0 ; 99]	50(*)	Opening high speed	(*) con PC33 = 02
11	[0 ; 99]	34(*)	Opening low start speed	(*) con PC33 = 02
12	[0 ; 99]	80(*)	Opening profile fittings	(*) con PC33 = 02
13	[0 ; 99]	40(*)	Closing high speed	(*) con PC33 = 02
14	[0 ; 99]	16(*)	Closing final low speed	(*) con PC33 = 02
15	[0 ; 99]	99(*)	Closing profile fittings	(*) con PC33 = 02
19	[0 ; 1]	1	Fire-Fighting mode	00 = closing force detection disabled 01 = reduced sensitivity
20	[1 ; 5]	1	Battery opening cycle duration (related to EOC command function)	Expressed in minutes
21	[0 ; 1]	0	Reversing source signal logic	00 = N.O. 01 = N.C.
22	[0 ; 1]	0	Closing rotation	00 = clockwise 01 = counter-clockwise
23	[0 ; 99]	70	% partial opening on AUXC active	00 = door closed ... 99 = door opened
24	[0 ; 1]	0	Reopening with reduced profile	00 = disabled 01 = enabled
25	[0 ; 1]	0	Door closed parking mode	00 = skate closed (continuous torque on the motor) 01 = skate opened (without additional torque on the motor)

N°	RANGE	DEFAULT	Name	Values Description
26	[0 ; 2]	1	Installed skate type	00 = S20 01 = S90 02 = S120
27	[0 ; 1]	0	Closing force detection when RSC active	00 = closing force detection DISABLED 01 = closing force detection ENABLED
32	[0 ; 1]	0	AUXC input options	00 = disabled 01 = partial opening floor input
33	[0 ; 5]	2	Speed profile	00 = 50% 01 = 75% 02 = 100% 03 = 125% 04 = 150%
34	[0 ; 2]	0	RVS output signal type	00 = active until DOC command from MLC. 01 = active until reopening completed 02 = active for 0.5s
36	[0 ; 1]	0	Maximum opening power (to be enabled only if strictly necessary because accelerate the system wear)	00 = disabled 01 = enabled
37	[0 ; 1]	1	DOS output activation without commands from MLC	00 = DOS active only if DOC active 01 = DOS active also in case of manual opening
38	[5 ; 40]	25	Door opened DOS activation tolerance	Expressed in mm
39	[0 ; 1]	0	Opening profile performances reduction, in front of motor overheating	00 = disabled 01 = enabled
42	[0 ; 1]	1	Closing force detection limit auto-tuning	00 = disabled 01 = enabled
43	[0 ; 1]	0	Door opened parking without torque	00 = disabled 01 = enabled
44	[1 ; 10]	02 (STD) 07 (EXP)	Clutch relaxing tolerance during CL parking with closed skate	Expressed in mm, adjustable with 1mm step.
45	[5 ; 305]	30	Clutch relaxing activation delay during CL parking with closed skate	Expressed in %: 0%=5s, 100%=305s. Default 30%=90s. Step 1%=3s
62	[-50;+50]	0	Opening deceleration offset	Expressed in mm
63	[-50;+50]	0	Closing deceleration offset	Expressed in mm
64	[0 ; 99]	18	Opening final low speed	Expressed in %. The value can change based on the speed profile selected
70	-	-	Speed profiles reset	-
90	0,1,2,3, 4,12,13	0	Installed motor type	0 = self-recognized 1 = Moog 1Nm 2 = Moog 2Nm 12 = GR63x25+SG80K 13 = GR63x55+SG120K 20 = M63x50+SN40(15:1) +Enc100 21 = M63x25+SN31(15:1)+Enc100 23 = M48x60+SN22,6(7:1)+Enc100
91	1,2,12,13, 20, 21,23	-	Recognized motor type	Refer to the previous parameter values
99	[0 ; 2]	0	MLC commands interface logic	0 = DOC DCC RSC in normal logic, RSC is forced closing signal 1 = DOC DCC RSC in reversed logic, RSC is a reduced speed movement enable signal 2 = DOC DCC RSC in normal logic, RSC is a reduced speed movement enable signal

- Table23: parameter list of the CDD5.0 door drive -

5.1 Door operator configuration Parameters

The present paragraph reports the description of all the parameters related to the set-up of the door operator, to associate the door drive to the installed door operator type.

With the auto-set procedure the drive automatically recognizes: motor type, closing rotation, skate type and learns the skate and door space; this procedure permits to the controller to learn the exact skate space, with important advantages respect to the manual settings where the nominal skate space is applied. In case it is preferred to proceed with the standard door learning, it is necessary to set all the parameter of the door operator, before starting the procedure.

5.1.1 PC26: installed skate type

The installed door operator where the CDD 5.0 is mounted, may have different skate types. To have a correct behaviour (opening and closing speed profiles, final approach to the panels closed, reversing, etc.), it is necessary to set the correct value for this parameter.

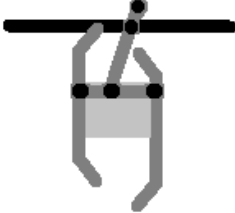
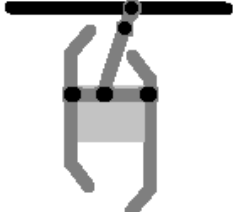















Parameter value	Related automatic settings	Note s	Skate representation
00 = skate S20	Aluminium skate Skate space = 20mm OP acceleration start = 20mm CL deceleration end = 25mm	The space measured on the belt between the skate opened and skate closed positions is about 20mm	
01 = skate S90 (default value)	Iron Skate Skate space = 90mm OP acceleration = 90mm CL deceleration end = 100mm	The space measured on the belt between the skate opened and skate closed positions is about 90mm	
02 = skate S120	Iron Skate Skate space = 120mm OP acceleration = 120mm CL deceleration end = 125mm	The space measured on the belt between the skate opened and skate closed positions is about 120mm	

- Table 24: main skate types -

 : it is possible to set manually any installed skate type, in case the installed skate results different from the ones reported in the previous table, modifying the “sub-parameters” indicated in the “Related automatic settings” of the previous table (accessible only by external handset). It is suggested anyway to perform in this case the auto-set procedure, to learn the exact values for all the parameters influenced by the actual skate space measured on the belt.

5.1.2 PC90: installed motor type

This parameter permits to set the installed motor type, applying the automatic selection or setting manually the installed motor code, as reported in the table below:

Motor type	Reference image								
00 = self-recognized	The door drive automatically detects the motor type connected at every power on. To avoid the self-recognizing cycle at every power on, set manually the motor type. Motors automatically recognized:								
	<table border="1"> <tr> <td>01</td> <td>02</td> <td>12</td> <td>13</td> </tr> <tr> <td></td> <td></td> <td></td> <td></td> </tr> </table>	01	02	12	13				
01	02	12	13						
									
01 = Moog 1Nm (4:1 belt) + Enc500									
02 = Moog 2Nm (4:1 belt) + Enc500									
12 = GR 63x25 + SG80K (15:1) + Enc100									
13 = GR 63x55 + SG120 (15:1) + Enc100									
20 = M63x50 + SN40 (15:1) + Enc100	-								
21 = M63x25 + SN31 (15:1) + Enc100	-								
23 = M48x60 + SN 22,6 (7:1) + Enc100	-								

- Table 25: selectable motor list -

5.1.3 PC22: closing rotation sense

The motors installed on the field can have the rotation pulley mounted on the right or on the left respect to the motor shaft: this means that the motor, to rotate in the correct sense need to rotate in opposite sense based on the installation type. This parameter permits to configure the correct closing rotation sense, as reported in the following table:

Parameter value	Notes
00 = clockwise (default value)	The motor pulley, in frontal view, rotates in clockwise sense when door is closing.
01 = counter-clockwise	The motor pulley, in frontal view, rotates in counter-clockwise sense when door is closing.

The check of the rotation sense can be executed with door operator switched off, or checking the door movement with the door drive in Inspection mode.

5.1.4 PC05: car door locking device settings

This parameter allows to configure the system to manage the unlocking operation when the car door locking device is installed, as reported in the table below. The main function executed by the door controller in case the car door locking device is present is the unlocking movement when main power is off, to permit the evacuation from the car to the floor.

Parameter value	Notes
00 = not present (default value)	The car door locking device is not present: in case of black-out, when door is closed, the controller keeps the skate closed, with the residual energy stored inside the controller.
01 = present 	The car door locking device is present: in case of black-out, when door is closed, the controller tries immediately to open the skate and the panels for at least 20mm, with the residual energy stored inside the controller. If the cabin is inside the unlocking zone, this movement permits the unlocking of the hook, and the consequent possibility to open manually the car and landing door. If the car is outside the unlocking zone, this movement is not permitted by the hook, and the car door remains blocked, because the evacuation is not possible.

5.1.5 PC06: glass door settings

This parameter allows to configure the installed door type, if with or without glass panels, to activate if necessary the functions related to the glass panels, according to the standards limits.

Parameter value	Notes
00 = door panels not glazed (default value)	All the door panels of the lift haven't glass panels
01 = glazed door panels	At least one of the door panels of the lift has glass



: refer to paragraph 8.6 for the verification of the standards limits.

5.1.6 PC99: MLC interface logic settings

This parameter permits to configure the MLC commands (DOC, DCC, RSC) management on the door drive, even from the input logic side, that on from the function of the RSC, as reported in the following table:

Parameter value	Notes
00 = DOC DCC RSC active high and RSC function is forced closing at reduced speed signal (default value)	The DOC DCC RSC are high active (the MLC closes the signals to the used 24Vdc). The RSC signal is a forced closing signal. The activation of the RSC from the MLC means the high priority closing with reduced speed, even if DOC signal is active.
01 = DOC DCC RSC active low, RSC function is reduced speed movement enable signal	The DOC DCC RSC commands are low active (the MLC closes the signals to the used 0V). The RSC command is the enable signal for the reduced speed movement. The activation of the RSC itself does not start any movement, but: DOC + RSC = opening with reduced speed DCC + RSC = closing with reduced speed
02 = DOC DCC RSC active high, RSC function is reduced speed movement enable signal	The DOC DCC RSC commands are high active (the MLC closes the signals to the used 24Vdc). The RSC command is the enable signal for the reduced speed movement. The activation of the RSC itself does not start any movement, but: DOC + RSC = opening with reduced speed DCC + RSC = closing with reduced speed

The following table reports the functional description of all the DOC, DCC and RSC signals combination, when PC99=0:

The \uparrow symbol means the activation edge of the signal, from off \rightarrow on status

The \downarrow symbol means the deactivation edge of the signal, from on \rightarrow off status

DOC	DCC	RSC	Door movement
0	0	off	Door stopped (according to PC02=0 default value)
0	0	\uparrow	The door closes with reduced speed.
0	0	on	
0	0	\downarrow	The door stops, from the previous forced closing at reduced speed
\uparrow	0	off	The door starts opening with normal speed
\uparrow	0	on	The door remains closed or continues to close at reduced speed, based on the door position.
1	0	off	The door opens with normal speed
1	0	\uparrow	The door stops the opening movement, and reverses closing at reduced speed
1	0	\downarrow	The door stops the reduced speed closing, and reverses opening with normal speed
0	\uparrow	off	The door starts closing with normal speed
0	\uparrow	on	The door continues to close with reduced speed
0	1	off	The door closes with normal speed
0	1	\uparrow	The door reduces the speed and continues to close with reduced speed
0	1	\downarrow	The door completes the closing movement with reduced speed

The following table reports the functional description of all the DOC DCC and RSC signals combination, when PC99=1 or PC99=2:

DOC	DCC	RSC	Door movement
0	0	off	Door stopped
0	0	on	Door stopped
0	0	\uparrow	Door stopped
0	0	\downarrow	Door stopped
\uparrow	0	off	The door starts opening with normal speed
\uparrow	0	on	The door starts opening with reduced speed
1	0	off	The door opens with normal speed
1	0	\uparrow	The door reduces the speed and continues to open with reduced speed
1	0	\downarrow	The door completes the opening movement with reduced speed
0	\uparrow	off	The door starts closing with normal speed
0	\uparrow	on	The door starts closing with reduced speed
0	1	off	The door closes with normal speed
0	1	\uparrow	The door reduces the speed and continues to close with reduced speed
0	1	\downarrow	The door completes the closing movement with reduced speed

5.2 Speed profiles

5.2.1 P33: Pre-set Speed Profiles

The speed profiles can be changed simply selecting the value of this parameter PC33, that offers the possibility to choose between 5 pre-set speed profiles:

Parameter value	Notes	Performances
04	Profile 150%	 <p>Fast</p> <p>Slow</p>
03	Profile 125%	
02 (default value)	Profile 100%	
01	Profile 75%	
00	Profile 50%	



: refer to paragraph 8.6 to check the standards and code limits.

The speed profiles are associated both to opening and closing, as shown in the following table:

Profile	Parameters	Default Profile				
		50%	75%	100%	125%	150%
OPENING	High speed	30%	40%	50%	70%	90%
	Low start speed	34%	34%	34%	34%	34%
	Fittings	99%	90%	80%	70%	60%
	Low final speed	18%	18%	18%	18%	18%
CLOSING	High speed	30%	35%	40%	50%	60%
	Fittings	99%	99%	90%	90%	90%
	Low final speed	16%	16%	16%	16%	16%



NOTE: the reported values refers to default conditions, and may be different based on the installed firmware version.

In case it is necessary to fine tune the speed profiles, it is possible to change the following parameters related to the profile (some of these are accessible only from external device):

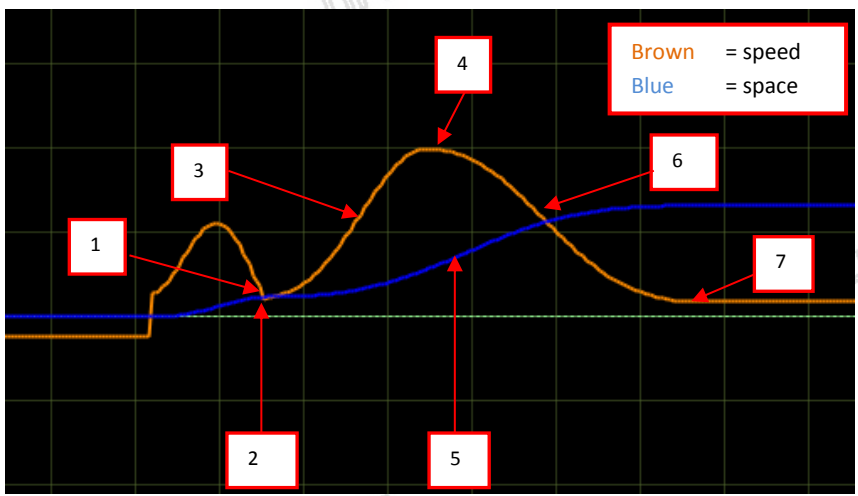
Parameter	Description
1.Low start speed	
2.Opening acceleration start / Closing deceleration end	
3.Acceleration	
4. High speed	
5.Deceleration offset	
6.Deceleration	
7.Low final speed	
8.Fittings	

5.3 Reversing management in closing direction

5.3.1 PC00: reversing events management

Parameter value	Notes
00 = internal (default value)	The door drive, once received the activation of a reversing source, external or internal (closing force limiter), reopens automatically the door activating the RVS output, without waiting for any command from the MLC.
01 = external when moving	The door drive, once received the activation of a reversing source, external or internal (closing force limiter), stops the current movement, activates the RVS output and waits for a command from MLC.
02 = external moving + parking.	As previous value, in addition the door drive checks the external reversing sources (barriers, photocells) status, if directly connected to it, also during parking with door opened. In case the reversing sources are active, the drive will not execute closing command and activates RVS.

NOTE: if values 01 or 02 are set, the controller waits always for a DOC command from the MLC to reopen; if after 0.5s from the reversing event activation the DOC command is not yet active, the door starts to close with reduced speed and activates the AL03 warning to store the MLC reversing not activated in the statistics.

5.3.2 PC34: RVS output activation type

This parameter regulates the RVS output duration, as reported in the following table:

Parameter value	Notes
00 = active until DOC command activated	The door drive, once the external reversing source is active or the closing force limiter is active, activates the RVS output that remains active until MLC will activate its DOC command.
01 = active until reopening completed (default value)	The door drive, once the external reversing source is active or the closing force limiter is active, activates the RVS output that remains active until the reopening movement is completed.
02 = active for 0.5s.	The door drive, once the external reversing source is active or the closing force limiter is active, activates the RVS output for 0.5s.

NOTE: 00 and 02 values are active only if PC00 is different from 00.

5.3.3 PC42: Closing force limit Auto-set

This parameter permits to enable/disable the auto-tuning function of the closing force limit:

Parameter value	Notes
00 = disabled	The closing force limit auto-tuning function is not active, and the set value for the closing force limit (see next page) remains unchanged.
01 = enabled (default value)	<p>The auto-tuning function is active::</p> <ul style="list-style-type: none"> - Every time that the closing force limiter detects an obstacle, a reversing event is generated. The closing force limiter automatically increments the closing force limit by 6N, until the maximum value FMAX - Every time that a closing movement is completed without obstacle, the closing force limiter automatically decreases the closing force limit by 0.1N, until the minimum value FMIN <p>This management permits to adapt the system reaction to the change of frictions. IMPORTANT: when this function is enabled it is very important to define the FMIN limit to avoid false reversing and assure that reversing happens according active codes.</p>



5.3.4 PC09: Closing force detection settings

The closing force limit sets the threshold to recognize an obstacle during the door closing; it can be changed from a pre-set minimum value FMIN, until to a maximum value FMAX; also these limits can be changed but only with the external device (handset or similar device).

Together with parameter PC42 (previous paragraph), this parameter permits a complete management of the closing force reversing limit.

There can be particular field installations that have non optimal working conditions, and where it is necessary to increase the FMAX limit above the nominal 150N. in this case it is strictly necessary to measure the actual closing force limit for reversing with a specific instrument, to guarantee the codes limits.

Forces	Default value	Note
FMIN	110N	Adjustable between 80N and FMAX
FSET	130N	Adjustable between FMIN and FMAX
FMAX	150N	Adjustable between FMIN and the maximum force available for the installed motor

5.3.5 Reversing Disabled offset at the end of closing

This parameter allows to fine tune the obstacle detection disabled space, that disable also the closing force limiter, at the end of the closing movement. The parameter represents the offset respect to the position of panels closed and skate opened. The set value may be affected by possible errors related to the skate settings, or skate measurement during installation. The correct settings of the skate PC26 (paragraph 5.1.1) has to be verified, before applying any modification to this parameter.

Value	Value in mm	Notes
0%	-20mm	Minimum: the closing force limiter is active also when panels are closed and the skate is partially closed
100%	0mm	Panels closed and skate opened position
Default	+2mm	This settings allows to theoretically detect obstacle: 2mm in case of side doors 4mm in case of centre doors
200%	+20mm	Maximum: the closing force limiter is disabled 20mm before the panels are closed.



IMPORTANT: the set value is a theoretical value, and it is strongly affected by external factors (belt tension, mechanical tolerances, etc.). verify the actual minimum obstacle detected and perform a fine tuning in case of need.

5.4 MLC interface management

5.4.1 PC01: MLC commands check mode

This parameter defines how the door drive checks the commands coming from MLC. The following table shows the possible options:

Parameter value	Active command status	Notes
00 = level (default value)	Signal level always checked	The command is considered active until the input signal is closed to the common voltage. During parking the command can be removed
01 = level also during parking	Signal level always checked	As the previous, but in addition the command is checked also during parking. If it is removed, the controller removes the related active parking output
02 = edge		One activation edge of the command is enough to generate a complete door movement. Suggested only when strictly necessary (old MLC compatibility)

5.4.2 PC02: reaction of door drive if no MLC command

This parameter defines the behaviour of the door drive when no commands are present from MLC, when the door is at intermediate position (not completely closed and not completely opened).

Parameter value	Notes
00 = instant stop (default value)	The controller, in case no commands are present, stops immediately the door and keeps the actual position with low torque applied to the motor.
01 = low speed + stop	The controller completes the current movement with reduced speed until the final position is reached
02 = low speed cycle	The controller executes a reduced speed cycle: at the commands interruption, the door opens completely with reduced speed, remains opened for 30s, then closes completely with reduced speed (evacuation oriented).

5.4.3 PC03: Alarm enabling if no MLC commands

This parameter allows to activate an warning code (AL01), in case no commands from the MLC are present, to store the number of this event type. Not suggested if MLC usually removes commands (i.e. during parking).

Parameter value	Note
00 = disabled (default value)	Alarm AL01 not enabled
01 = enabled	Alarm AL01 enabled

5.5 Input signals management

5.5.1 PC04: RVC input function

This parameter permits to set type and function related to the RVC command input.

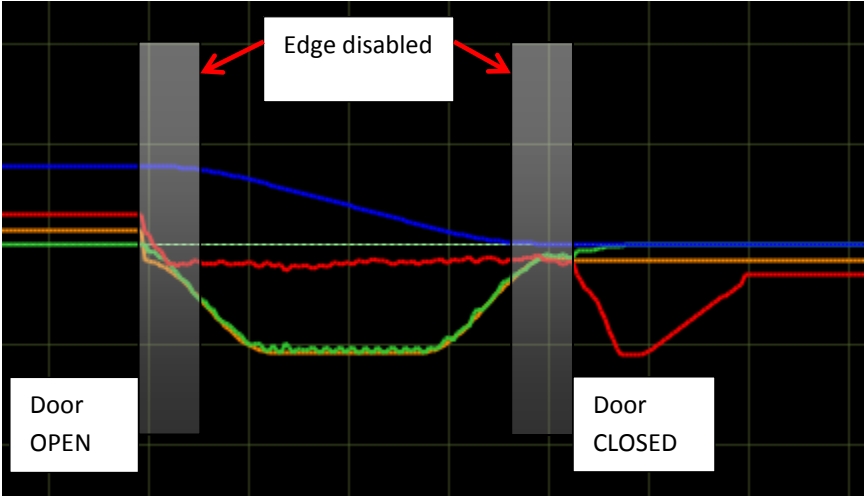
Parameter value	Notes
00 = edge reversing input signal (default value)	The signal connected to the RVC pin is a dry contact from an external reversing source (light curtains, photocells, ...). The activation of the signal during door closing implies the door reversing until the complete reopening of the door (according to PC00 settings that defines if the controllers reopens automatically or waits for a MLC DOC command)
01 = level reversing input signal	The signal connected to the RVC pin is a dry contact from an external reversing source (light curtains, photocells, ...). The activation of the signal during door closing implies the door reversing and reopening until RVC is active (according to PC00 settings that defines if the controllers reopens automatically or waits for a MLC DOC command)
02 = mechanical safety edge	<p>The signal connected to the RVC pin is a dry contact from an external retractable safety edge. In this case the controller applies a signal filter to disable the input signal based to the door position, when the door is in the “blind zones” of the safety edge, that means the positions where the edge retracts automatically near to the door opened position and near to panels closed position.</p> <p>The values of these “blind zones” are programmable only with the external device as sub-parameters: “Disabling threshold start closing”: default 50mm, adjustable from 1mm to 100mm “Disabling threshold end closing”: default 50mm, adjustable from 1mm to 100mm.</p> <p>The diagram below reports the “blind zones” position:</p> 

5.5.2 PC21: reversing inputs logic settings

This parameter allows to set the reversing inputs signal logic.



ATTENTION: the parameter is one for both RVC and DETC inputs. This implies:

- The signal logic of the devices connected to RVC and DETC must be the same
- In case of reversed logic, the input eventually not connected must be bridged to the used common voltage

Parameter value	Note
00 = Normally OPEN (default value)	The signals connected to RVC and DETC inputs are normally open signals
01 = Normally CLOSED	The signals connected to RVC and DETC inputs are normally closed signals

5.5.3 PC32: AUXC input function

This parameter allows to set the AUXC input function.

Parameter value	Notes
00 = disabled (default value)	No function is associated to the AUXC input
01 = partial opening	<p>The signal connected to the AUXC input is a special contact that is active when the car is stopped at one or more particular floors that have landing doors with different reduced opening space.</p> <p>With the PC23 parameter “% partial opening” it is possible to set the opening percentage based on the door learned space associated to the complete car door opening space.</p> <p>Example: side car door, width 1200mm Special floor with 1000mm opening space → $PC23 = (1000/1200)\% = 83\%$</p> <p>Example: Central car door, width 1200mm Special floor with 1000mm opening space In this case the door is seen from the door drive as $1200\text{mm}/2 = 600\text{mm}$ but the proportion remains unchanged ⇒ $PC23 = (1000/2) / (1200/2) = 1000/1200 = 83\%$.</p>
02 = external “anti-finger trapping” device	The signal connected to the AUXC input comes from an anti-finger trapping device, to activate the reversing during opening: the reclosing is performed until the signal is active and for 1s after the AUXC signal is no more active. Normally it is a sensitive strip applied to the moving door panels made with glass, to prevent the finger trapping.

5.5.4 PC27: RSC options

This parameter permits to set the behaviour of the controller closing force detection, when RSC command is activated from MLC, and when PC99=0 that means RSC is a forced closing signal.

Parameter value	Notes
00 = closing force limiter disabled (default value)	The door drive, during the reduced speed forced closing, applies a reduced force, but does not reverse in case of impact with an obstacle. The force applied to the obstacle is always less than 150N
01 = closing force limiter enabled	The door drive, during the reduced speed forced closing, keeps the closing force limiter enabled. In case of closing force detection, the reversing cycle is activated, according the PC00 settings.

5.5.5 PC19: FFC options

This parameter sets how the controller manages the closing force limiter, when the FFC command is active, and the system is in Fire-Fighting mode. The other reversing sources eventually connected to the controller (barriers, photocells) are always disabled when FFC command is active.

Parameter value	Notes
00 = closing force limiter disabled	The controller, when in Fire-Fighting mode, drives the door closing with the closing force limiter disabled (the door operation are manually managed by the fire-fighter directly from the car)
01 = Closing force limiter enabled with reduced sensitivity (default value)	The controller, in any door closing condition (also during reduced speed closing), keeps the closing force limiter active, with sensitivity reduced to the minimum.

5.5.6 PC20: EOD function time-out (based on EOC input)

This parameter allows to change the total time of the emergency opening cycle. This function is active when:

1. The emergency battery is connected to the door drive (+ and – plugs of the X4 connector)
2. The EOC contact is installed at the evacuation floor, and connected to the EOC input plug of the X3.2 connector.

In this way, when the main power supply fails, the MLC drives the car to the emergency floor. The door controller then detects the KEOD input active, and proceed with a temporized opening of the door. Once the set time is elapsed, the door will close.

The total time of this cycle (from door closed to door closed) is defined with this parameter. The parameter is expressed in minutes and it is adjustable in the range [1 ; 5]minutes. The default value is 1'.

5.6 Output signals management

5.6.1 PC07: AUXS output options

This option permits to configure the AUXS output, that is a double contact relay.

Parameter value	Notes
00 = disabled	The AUXS output not used
01 = active during door opening	The AUXS output is active when the door is opening. In this case it is normally connected to an acoustic device (gong), that indicates the opening movement in progress.
02 = space percentage	The AUXS output is active when the door position reached is higher than the space percentage indicated by the PC08 parameter
03 = Error signal (default value)	The AUXS output is active when the door drive is in alarm status, or in case of motor overheating.

5.6.2 PC37: DOS output activation options

The door drive DOS outputs, indicates to the MLC that the door is open. The output management can be operated in two ways: check only the door open position, or checking that the door open position is reached only when a command is present.

This option permits to configure the activation of the DOS output, also when no command are present from MLC; by default this option is active, this means that also a manual moving of the door until the door is open will involve the activation of the DOS output. For some MLC type, this management may activate a MLC error, and this option has to be disabled.

Parameter value	Notes
00 = off	DOS outputs is not activated if no MLC DOC command is present
01 = on (default value)	DOS output is activated also if no MLC command is present

5.6.3 PC38: DOS output activation threshold

This parameter allows to configure the DOS output activation threshold. During the door opening, the controller checks that door position reaches the door opened position, verifying:

1. The space quote is reached
2. The end position is reached, detecting panels hitting the bumpers

To cover installation tolerances, this parameter permits to accept door open position lower than learned position, until 40mm less.

- Default value: 25mm
- Range: [5 ; 40]mm

The figure below shows the operating zone of the parameter:

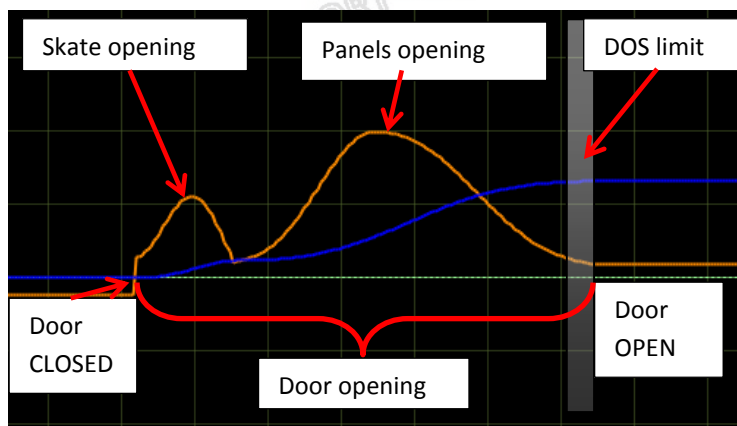

- Figure 5-1: door opening profile and DOS activation zone -

5.7 Door Closed parking management

5.7.1 PC25: Door Closed Parking mode

This parameter permits to enable the “Parking with Skate Opened” (PSO) function.

Parameter value	Notes
00 = PSO not active (default value)	The controller, during parking with door closed, keeps ALWAYS the skate closed, applying a reduced parking torque to the motor enough to keep the closed position.
01 = PSO active	The controller enables the PSO function

The door closed parking phase generates, mainly for long parking period during lift unused time, a power consumption and a continuous torque applied to the motor to keep the skate closed also if the car is parking at the floor.

For this reason the PSO function has been developed. To manage this option, it is necessary that MLC:

1. Removes DCC command when car is parking at the floor without calls
2. Not activate error or alarms, in case the safety chain gets open during the parking phase at floor after PSO activation (the open skate opens the locks)
3. Activate DCC command at least 2s before the car starts to move for a call

If all the previous conditions are satisfied, it is possible to exploit all the advantages given by the PSO function.

In the table below are reported all the parameters that configure the PSO management. These parameters are accessible ONLY by external handset device with the following path: Main Menu → Advanced Settings → Parameters → Closed parking mode.

Parameter	Range	Default value	Description
PSO activation delay	[5 ; 999] s	240s	Represents the delay starting from deactivation edge of DCC command, at door closed, before to enter in PSO
PSO skate opening space	[5 ; 150]mm	STD: 20mm EXP90: 90mm EXP120: 120mm	Represents the opening space at reduced speed to reach the skate open position and panels closed
PSO position error	[2 ; 20] mm	10mm	Maximum position error in opening direction, after which the DCS is disabled and the controller gets out of PSO mode
PSO position control	[0 ; 1]	0	0: the motor is not powered and the panels are free to be moved 1: a reduced torque position control is enabled to avoid panels opening. The torques is applied on the motor only if necessary

The PSO function activation sequence is reported in the table below:

N.	Phase	MLC signals	CDD5 signals	Notes
1	Closed skate parking	DCC active RSC not active	DCS active	Skate closed, parking torque applied to the motor
2	Delay to open skate	DCC not active RSC not active	DCS active	Door drive waits for PSO activation delay expiration. If during this phase DCC is activated the door drive returns to phase 1
3	Skate opening	DCC not active RSC not active	DCS active	The door drive opens the skate until the position defined by parameter "PSO skate opening space". If in this phase DCC is activated the controller goes to phase 5
4	Parking with opened skate	DCC not active RSC not active	DCS active	The door drive is in active PSO, with opened skate and panels closed; the position control is set according to the related parameter "PSO position control". If in this phase DCC is activated the door drive goes to phase 5
5	Skate closing	DCC active RSC not active	DCS active	The door drive closed the skate, because of DCC active
6	DCS deactivation	DCC not active RSC not active	DCS not active	If an external force moves the panels in opening direction to a position higher than "PSO position error", the controller removes the DCS output and returns to wait for a MLC command.



: if in any phase of this sequence the MLC activates the DOC command, the door begins immediately the requested opening movement, starting from the current door position.

5.7.2 PC44: Door closed Reduced torque relaxing tolerance

The door closed and skate closed parking management is composed by two phases (in case PSO function is not active):

1. Parking with maximum parking torque
 - a. The controller applies the maximum parking current to the motor, as defined by the "maximum parking current" parameter for the closing profile
2. Parking with reduced torque
 - a. If there are no commutation in the DCC (or RSC if P99=0) signals, after a programmable delay defined by parameter PC45, the controller applies a gradual relaxing of the belt, to reduce the torque applied to the motor, without relaxing the belt position over a pre-defined threshold (PC44). In case this threshold is passed, the controller proceeds to the position recovering, and then restarts the delay counting.

This parameter allows to program the maximum relaxing threshold acceptable during door closed parking phase, with reduced torque.

Parameter PC44	Range		Default value		Description
Reduced torque parking relaxing tolerance	S20 S90 S120	[1 ; 5]mm [1 ; 20]mm [5 ; 20]mm	S20 S90 S120	2mm 7mm 7mm	Maximum relaxing acceptable during CL parking with reduced torque

5.7.3 PC45: Door closed Reduced torque activation delay

This parameter permits to change the activation delay for the reduced torque parking, as described in the previous paragraph.

PC45 Parameter	Range	Default value	Description
Reduced torque parking activation delay	[5 ; 305] s	90s	The delay is reset every time that the door drive detects a change in DCC (or RSC if PC99=0) commands. During the reduced torque parking phase, if the DCC (or RSC if PC99=0) commands from OFF to ON, the controller returns to park with nominal torque, and the delay restarts

5.8 Particular Parameters

5.8.1 PC43: Door open parking with reduced torque

This parameter permits to enable the opening parking without torque applied to the motor. There are some field installations with landing manual swing doors, and car automatic sliding doors, the normally park at the floor with the car door opened to permit the manual opening of the landing swing door.

This condition, similarly to the closed parking management, implies a continuous torque applied to the motor. To avoid this it is possible to enable this function.

Parameter value	Notes
00 = OP parking with reduced torque NOT ACTIVE (default value)	The controller, during the OP parking phase, keeps always active the parking torques to the motor.
01 = OP parking with reduced torque ACTIVE	The controller activates the OP reduced torque parking function

5.8.2 Reduced Speed value

This parameter allows to change the reduced speed value, used for the following movements:

- Power-on synchronization trip
- Learning trip
- Reduced speed trips (when RSC is active)

It is accessible only by external handset device: Main Menu → Advanced Settings → Reset speed. The table below reports the parameter details:

Parameter	Range	Default value
Reduced speed	[0.05 ; 0.25] m/s	0.07 m/s

5.8.3 Door Stopping space

This parameter permits to modify the stopping and reversing space after:

- Deactivation of the commands
- Reversing in progress due to commands switch of reversing source activation.

It is accessible only by external handset device: “Main Menu” → “Advanced Settings” → “Parameters” → “Reversing space”. The set value defines the space necessary to stop the door (measured on the belt). This means that for center doors this space will be seen doubled on the panels. This parameter is accessible only by external handset device.

Parameter	Range	Default value
Reversing space	[5 ; 60] mm	30mm

5.8.4 PC24: “smooth” reopening

This parameter allows to enable/disable the reopening movements with a “soft” speed profile, especially for heavy application, or when the elasticity of the system is very high.

Parameter value	Note
00 = Reopening with “soft” profile NOT ACTIVE (default value)	The controller applies, for the reopening or partial opening profiles, the standard calculated speed profile
01 = Reopening with “soft” profile ACTIVE	The controller applies, for the reopening or partial opening profiles, a reduced speed profile respect to the calculated one

5.8.5 PC36: door opening maximum power option

This parameter permits to enable the maximum available power for the opening movement, in case of particular heavy applications. The activation of this option allows to reach better performances, but has negative effects on the motor lifetime, and mechanical system stability.

NOTE: it is strongly suggested to contact Computec technical support before setting this function, to better evaluate other set-up opportunity.

Parameter value	Note
00 = Maximum opening power NOT ACTIVE (default value)	The controller applies, for the opening profiles, the factory pre-stores maximum power
01 = Maximum opening power ACTIVE	The controller applies, for the opening profiles, the maximum available power

5.9 Motor Thermal management

The monitoring of the motor thermal state is important to:

- Prevent motor over-heating
- Preserve the motor to extend its lifetime
- Prevent functional problems

The motor in use does not have temperature probes installed inside, for this reason the motor temperature is estimated based on a i2T model. For each motor type are defined the Thermal Resistance and Capacity, used with the motor current to calculate the motor temperature estimation.

Under particular working condition (wrong mechanical or electrical settings, too heavy door for the installed motor type, additional frictions, etc.), it can happen that during the normal working cycle of door opening and closing, the estimated motor temperature derives, this is a symptom of motor over-heating. If the estimated motor temperature becomes higher than the alarm threshold, the door drive stops the door and activates AUXS output (if configured by PC07), and waits for the temperature recover to restart normal behavior..

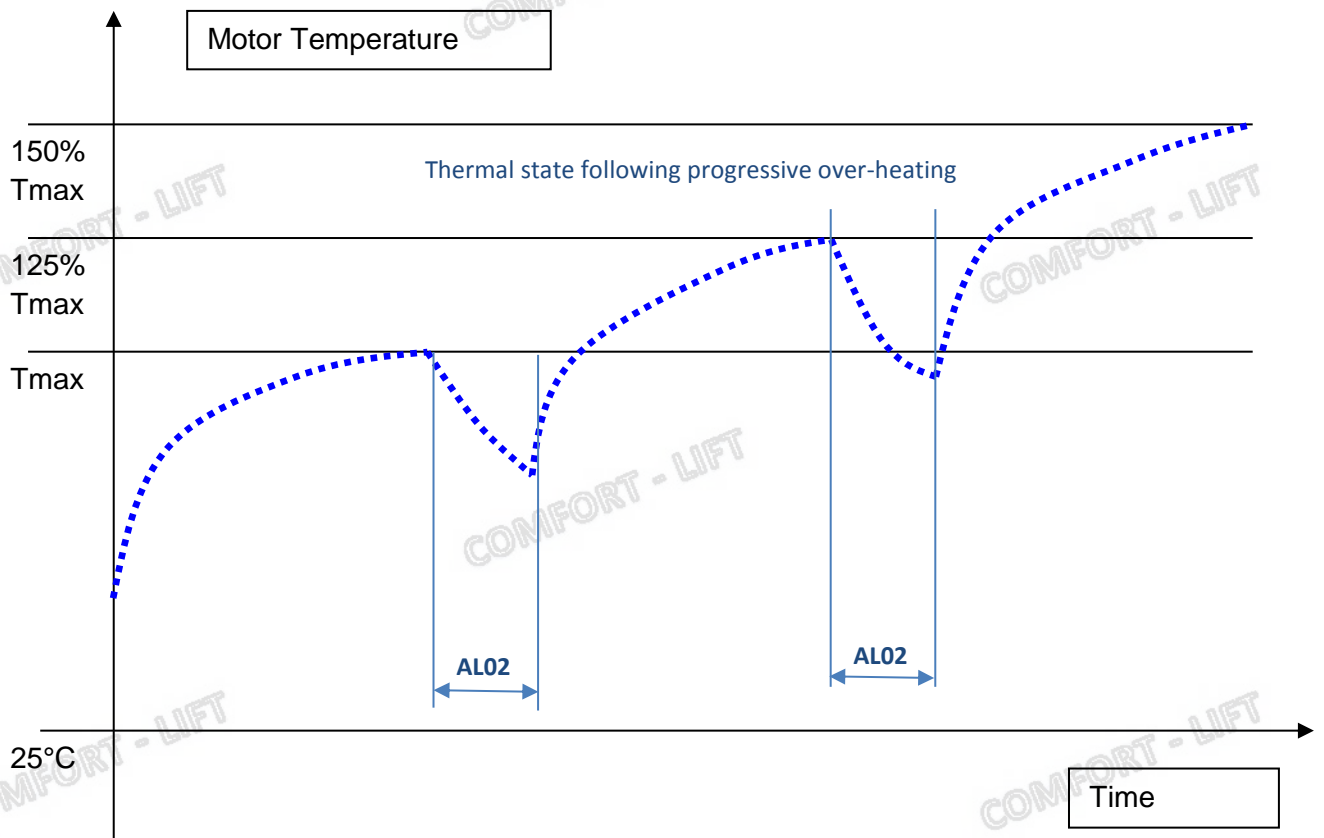

- Figure 5-2: thermal trend under progressive over-heating conditions -

The repetitive activation of thermal protection, is a clear symptom that the working conditions are not correct for the installed system, and deep checks have to be performed on the mechanical system and settings and on the motor / door moving mass ratio.

5.9.1 PC39: automatic opening speed profile reduction

To prevent lift stops, in case of particular working conditions, the controller can automatically reduce the opening speed profiles (proportionally to the temperature), when estimated motor temperature is higher than 80% of the maximum allowed temperature. This function is managed by parameter PC39.

PC39 Parameter value	Notes
00 = Speed profile reduction NOT ACTIVE	The controller applies the calculated normal speed profile, independently of the estimated motor temperature
01 = Speed profile reduction ACTIVE (default value)	The controller applies an opening speed profile progressively reduced, when the estimated motor temperature is higher than 80% of the maximum allowed motor temperature, that is the thermal protection alarm threshold.

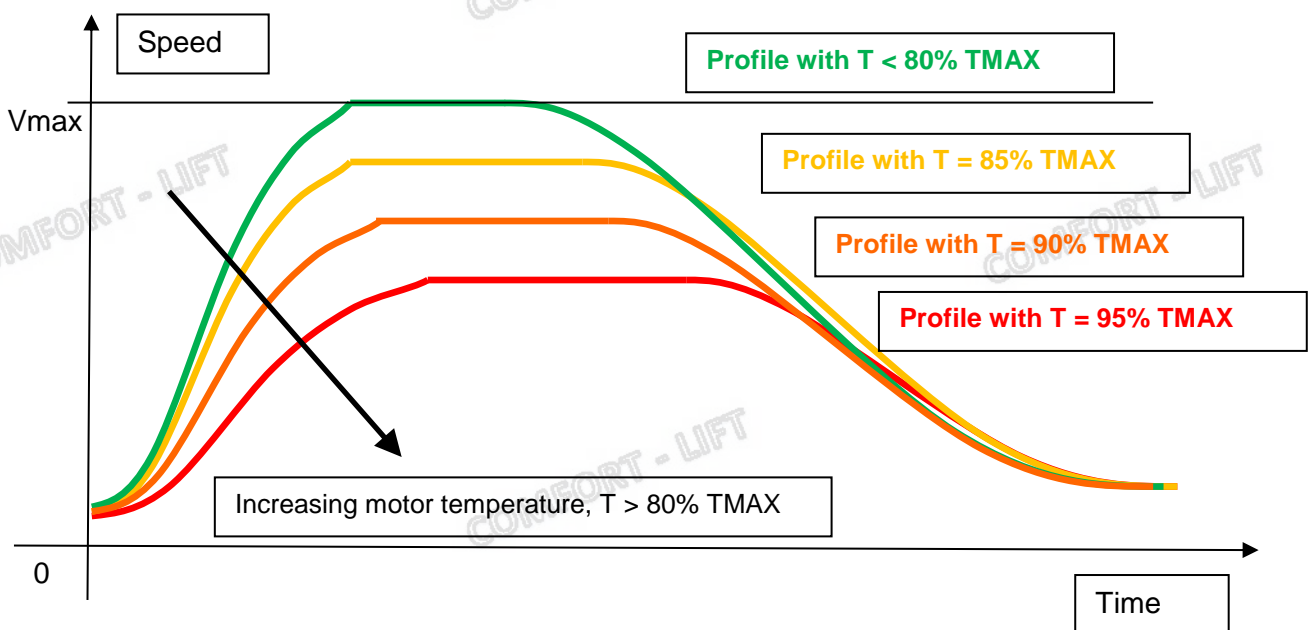

- Figure 5-3: progressive opening speed profile reducing when motor temperature increasing -

5.9.2 Management of door blocked during opening

The controller implements particular management of the possible door blocked events during door opening. If the door block happens inside the DOS activation threshold defined by parameter PC38 (refer to paragraph 5.6.3 “PC38: DOS output activation threshold”), the controller activates the DOS output and enters in normal door open parking.

In case the mechanical block happens before this position, the controller reacts according to the following table:

Door block position	Notes
Mechanical block within 20mm of panels closed position	The controller, once the mechanical block has been detected, proceeds with 5 consecutive unlocking retries.
Mechanical block within 2/3 of the door opening	The controller, once the mechanical block has been detected, reduces the motor torque within nominal values. If the obstacle is removed, the door will complete the opening with reduced speed. The DOS output is not active until PC38 defined position
Mechanical block between 2/3 of the door opening and the position defined by PC38	The controller, once the mechanical block has been detected, reduces the motor torque within nominal values. If the obstacle is removed, the door will complete the opening with reduced speed. The DOS output is active, to signal the anticipated door open condition and permit the normal working of the lift.
Mechanical block over PC38 defined position	The controller activates the normal door open parking

NOTE: for the first 3 events reported in the table, the door drive increase the internal occurrence counter of the warning AL12 “Mechanical block”.

6 Maintenance

6.1 Alarms

The CDD 5.0 door drive implements a warning/alarms/errors list, with which it can communicate functional errors external or internal of the CDD5; this codes are very important to detect the causes of issues during maintenance phase.

The following table reports the codes list.

Code	Type	Description	Controller actions	User actions
AL01	Warning	MLC signal error	The controller continues the normal work. Increased and stored the event counter	Check correct settings for PC01, PC02, PC03. Check MLC signals
AL02	Alarm	Motor over-temperature	The controller stops any movement for 5s, and then recovers normal working. In case the maximum allowed temperature is overpassed the controller waits for 3', to permit the motor temperature recovery.	Check if mechanical issue of frictions are present at all the floors. Check that the speed profile are not too fast for the system.
AL03	Warning	Failed external reversing	The controller completes the closing at reduced speed	Check correct PC00 settings. Check correct DOC activation from MLC after RVS activation from door drive Check correct cabling of RVS signal and DOC, DCC
AL04	Alarm	Motor connection error (the door moves in opposite direction)	The controller restarts within 10s to recheck if normal working conditions restored. After 5 consecutive errors within 5', the system stops waiting for maintenance.	Check correct motor connection on X4 plug: positive to 43 negative to 44 Check motor and cables integrity
AL05	Alarm	Motor encoder connection error	The controller restarts within 10s to recheck if normal working conditions restored. After 5 consecutive errors within 5', the system stops waiting for maintenance.	Check X5 connection of the encoder cable. Check encoder cable integrity
AL06	-	-	-	-
AL07	Alarm	Motor connection interruption	The controller restarts within 10s to recheck if normal working conditions restored. After 5 consecutive errors within 5', the system stops waiting for maintenance.	Check if motor connection are present on plug X4: positive to 43 negative to 44 Check motor integrity

Code	Type	Description	Controller actions	User actions
AL08	Alarm	Over-Voltage	The controller restarts within 10s to recheck if normal working conditions restored. After 5 consecutive errors within 5', the system stops waiting for maintenance.	Check that power supply input is within the declared operating range. Check that the speed profiles are not too fast for the installed system.
AL09	Alarm	Motor over-current	The controller restarts within 10s to recheck if normal working conditions restored. After 5 consecutive errors within 5', the system stops waiting for maintenance.	Check that no short-circuit are present on the motor output of the door drive. Check that motor is not short-circuited. Check the controller integrity: switch off the door drive, disconnect the motor plug. Switch on the door drive and check the AL09 is not present
AL10	Warning	Internal error	The controller restarts within 10s to recheck if normal working conditions restored, checking the internal units.	-
AL11	Warning	Power supply module over-temperature	The controller waits for the normal working condition restored	The controller is working under system/environmental/setting condition too heavy. Reduce the speed profiles in opening if frequent occurrence
AL12	Warning	Mechanical block during opening	Code stored in statistics The controller continues the normal behaviour	Check the presence of possible mechanical issue of abnormal friction on all the floors.

- Table 26: CDD 5.0 alarms/warning list -

6.2 Troubleshooting (FAQ)

The table below reports the most common possible issues, with the related solutions.

ID	Problem	Actions
1	The system does not switch on	<ul style="list-style-type: none"> - Check the presence of the main power supply voltage, within the declared operating range - Check that power cable is connected to X1 plug of the controller - Check status of F1 fuse - Check that ON button has been pressed
2	The panels don't move	<ul style="list-style-type: none"> - Check that no obstacle/frictions are present and that the panels movement is free - Check that all motor connections are present - Check main power supply presence - Check that door drive is powered and switched on - Check the door movements in Inspection mode
3	The system switch on , but the door does not move properly	<ul style="list-style-type: none"> - Check the movements in Inspection mode: <ul style="list-style-type: none"> o if the door is moving in the opposite side → check PC22 settings o if the display shows an alarm code → refer to the alarms table - Check the speed profiles: <ul style="list-style-type: none"> o The door is moving with reduced speed → check if RSC input is active and that PC99 is correctly set o The door does not move and the display shows an alarm code → refer to the alarms table
4	The system moves properly in Inspection mode, but not in Normal mode	<ul style="list-style-type: none"> - Check if CDD5 is correctly set in Normal mode - Check the correct opening after DOC activation without RCS command active - Check the correct closing after DCC activation without RCS command active - Check correct settings of parameter PC99
5	The system does not react to the activation of the external reversing sources	<ul style="list-style-type: none"> - Check that external reversing sources are correctly connected to the door drive and that the wirings are correct - Check the reversing sources are correctly powered and switch according the obstacle presence. - Check the correct settings for parameters PC04 PC21
6	The system does not activate the closing force detection	<ul style="list-style-type: none"> - Check correct settings for closing force limit - Check correct settings of parameters PC00 PC09.

- Table 27: Trouble-shooting -

In the next paragraph are reported, in a more detailed way and as check-list, the main situations described in the previous table, with the related checks and actions to be performed so to fix the possible issue.

6.3 Correct working check sequence

The following table reports the sequence of checks and actions to be executed for a functional test on the field. Based on the problem found on the field, start the sequence from the related step.

Problem	Check	STEP	Question	Answer	Action
The system does not work	Main power supply voltage check	1	Is the controller powered? Is the front panel display showing “- -” “Op” o “Cl”?	NO	Go to step 2
				YES	Go to step 6
		2	Is the power supply cable connected to door drive?	The power supply cable is NOT connected	Connect power supply cable and return to step 1
				The power supply cable is connected	Go to step 3
		3	Check that power supply voltage is inside the declared operating range: [90;290]Vac single phase	The supply voltage is correct	Go to step 4
				The supply voltage is NOT correct	Correct power supply voltage and return to step 1
		4	Check CDD5 F1 fuse	F1 is open	Replace fuse F1 and return to step 1
				F1 is OK	Go to step 5
		5	Press ON button on the door drive front panel	The display is not showing anything	Go to step 6
				The controller starts	Go to step 7
		6	Check if the controller is in programming status. Plug the upgrade stick (with inside the correct version)	The green led of the usb stick starts blinking and the upgrade is in progress	Go to step 7
				The red led of the usb stick is on, or no leds of the usb stick are working	The controller is not working

(continues on the following pages until page 58)

Problem	Check	STEP	Question	Answer	Action
The system switch on but does not move properly	Movement check in Inspection mode	7	Activate the Inspection mode (press key 4 for 1s, or until INSP. Led is on)	Door already closed by external command ("CL" fixed on the display).	Go to step 8
				The display shows an alarm ("AL" alternate to alarm code)	Refer to alarms table (paragraph 6.1)
				If display shows "- -".	Go to step 8
		8	Press and keep pressed key 2 to open, then press and keep pressed key 3 to close and check the panels movement	The door is moving properly: it closed when key 3 is pressed and opens when key 2 is pressed	Go to step 9
				The door is not moving and the display shows an alarm ("AL" alternate to alarm code)	Refer to alarms table (paragraph 6.1)
				The door is moving in the opposite direction: it's closing instead opening and opening instead closing	Check the set closing rotation and correct parameter P22. Then return to step 7
		9	Check opening profile. Press and keep pressed key 3 to close completely the door, until "CL" is shown fixed on the display. Then press and keep pressed key 2 until the door is completely open ("Op" shown fixed)	The door opens correctly with the set speed profile	Go to step 10
				The door opens with reduced speed	The RSC command (X3.1.22) is active. Correct wiring or settings
				The door is not moving and the display shows an alarm ("AL" alternate to alarm code)	Refer to alarms table (paragraph 6.1)
				The door is not moving or is moving not properly	Apply the speed profiles reset (4.6.1.3). then return to step 7
		10	Check closing speed profile. Press and keep pressed key 3 to close the door, until the door is completely closed ("CL" shown fixed)	The door closes correctly with the set speed profile	Go to step 11
				The door closes with reduced speed	The RSC command (X3.1.22) is active. Correct wiring or settings
				The door is not moving and the display shows an alarm ("AL" alternate to alarm code)	Refer to alarms table (paragraph 6.1)
				The door is not moving or is moving not properly	Apply the speed profiles reset (4.6.1.3). then return to step 7

Problem	Check	STEP	Question	Answer	Action
The system is moving properly in Inspection mode, but does not work in Normal mode	Movements check in Normal mode	11	Check if the door drive is in Normal mode	NO	Activate normal mode (press key 4 for 1s, or until NORMAL led is on)
				YES	Go to step 12
		12	Apply an opening command to DOC input (X3.1.5)	The door opens properly with the set speed profile	Go to step 14
				The door opens with reduced speed	The RSC command (X3.1.22) is active. Correct wiring or settings
				The door is not moving and the display shows an alarm ("AL" alternate to alarm code)	Refer to alarms table (paragraph 6.1)
				The door is not moving or is moving not properly	Go to step 13
		13	Check if DOC command is really active: if available, with the external handset access to "MLC monitor" menu (4.4.2) and check if DOC is active (highlighted)	The DOC opening command is not active	Check commands wirings (X3). Check that supply voltages are correct . Then return to step 12
				The DOC opening command is active	Check that ONLY DOC command is active and that DCC or RSC are not active. Check the set speed profile and if necessary perform a speed profile reset (4.6.1.3). then return to step 12
		14	Apply a closing command to DCC input (X3.1.3)	The door closes correctly with the set speed profile	Go to step 16
				The door closes with reduced speed	The RSC command (X3.1.22) is active. Correct wiring or settings
				The door is not moving and the display shows an alarm ("AL" alternate to alarm code)	Refer to alarms table (paragraph 6.1)
				The door is not moving or is moving not properly	Go to step 15
		15	Check if DCC command is really active: if available,	The DCC closing command is not active	Check commands wirings (X3), in particular the DCC. Verify that all the supply voltages are correct. Then return to step

			with the external handset access to “MLC monitor” menu (4.4.2) and check if DCC is active (highlighted)		14
				The DCC closing command is active	Check that ONLY the DCC command is active. Check the set speed profile and if necessary perform a speed profile reset (4.6.1.3). then return to step 14
The system does not reverse after activation of one or more reversing sources	Check of the reversing sources, internal and/or external	16	Closing force limiter check. Open the completely the door. Close the door putting an obstacle between panels	The door, when the panels touch the obstacle, reverses and reopens.	Go to step 17
				The door, when the panels touch the obstacle, continues to push against the obstacle	Check the settings of the closing force limit PC09 and the PC00 setting: if PC00 set to external check that DOC command is activated from MLC after activation of RVS by the CDD5. Correct settings. Then repeat step 16
		17	Check reversing source connected to RVC input (X3.1.23): with the external handset access to “MLC monitor Q.M.” menu (4.4.2), activate the external reversing device and check that RVC is active (highlighted)	The RVC signal is active	Go to step 18
				The RVC signal is not active	Check RVC connection (X3.1.23) and verify the correct settings for: P04 (5.5.1) e P21 (5.5.2). Then repeat step 17
		18	Check reversing source connected to DETC input (X9): with the external handset access to “MLC monitor Q.M.” menu (4.4.2), activate the external reversing device and check that DETC is active (highlighted)	The DETC signal is active	Go to step 19
	The DETC signal is not active			Check the light curtains connection and the setting of PC21 (5.5.2). Then repeat step 18	
19	Check closing force limiter. Open completely the door. Then close the door putting an obstacle	The RVS outputs is active based on the settings of parameter PC34 (5.3.2).	Go to step 20		
	Check proper working of RVS output				

			between panels. with the external handset access to “MLC signal monitor” menu (4.4.2), and check that RVS output is active (highlighted)	The RVS signal is not active	Check the closing force reversing activates correctly. Check the settings of PC34 (5.3.2), if PC34=2 note that the RVS signal will be active only for 0.5s. Repeat with P34=0.
		20	From door open condition apply a closing command and check the actual closing profile	-	Check if any friction is present (dust accumulated on the sill, mechanical settings on the operator). Go to step 21
	Check false reversing (execute this test only in case the door reverses during closing without any obstacle)	21	Switch off the door drive and check manually the panels movement	Mechanical issues or frictions are present	Fix mechanical issue, remove the dust from the sill. Repeat step 20.
				The panels movement is free without any friction	Switch on the door drive and check the PC09 settings: if necessary increase the PC09 value and repeat step 20.

- Table 28: functional check sequence -

7 After sale

7.1 Customer support

A complete customer support is active to help field installer or maintenance people to problem solving, that cannot be reached with all the information contained in the present user manual.

Check on the website www.computeelectronics.com/cdd5 how to access to technical support.

7.2 Replacements

All the available replacement parts and the ordering information are available on the www.computeelectronics.com/cdd5 website. In addition to the CDD5.0 door controller, other parts can be ordered, as: power supply cable, complete connectors kit, usb firmware upgrade key. The order codes and available parts are always updates on the reported website.

It is always necessary to contact technical support for further information or suggestion.

7.3 Material disposal

It is necessary to follow laws and rules of the country where the door drive is installed, to proceed with the correct disposal of the materials, both in case of packaging parts or in case of failed parts not returned.

8 General information

8.1 General considerations

Before starting any operation, it is mandatory to read and understand all the information reported in the present user manual.

8.2 Confidentiality agreement

The hardware and software/firmware components that forms the CDD5 device and all the: information, ideas, concepts, know-how are intended confidential and exclusive property of Computec.

All the information reported in the present user manual and any other support given by Computec, has to be considered confidential and property of Computec, that reserves the author rights: no parts can be copied or reproduced in any form.

All the information reported in the present manual cannot be forwarded to others, without the written permission of Computec, through authorized personnel.

The customer that use the CDD5 system, is implicitly committed to:

- not use the confidential information that are property of Computec,
- not re-project the CDD5 system

All the information reported in the present manual are checked and correct at the moment of the document release. In any case this does not constitute any obligation from Computec, that reserves the rights to apply modification considered necessary, also without any notification.

Computec declines any responsibility about any damage or claim caused to people, animals or things, due to errors or wrong interpretation/comprehension of the present document.

8.3 Safety

All the maintenance operation or cleaning performed on the automation or on the door, and the replacement of any component must be executed only after power supply has been interrupted. No maintenance operations different from the ones described in the present manual have to be performed. For any other failure detected on the door parts, contact the authorized technical support or qualified personnel.

It is forbidden to remove or apply change/falsify the plates and labels attached/printed/fixed from the manufacturer on the automation or on any related accessory parts.

In case the intended use of CDD5 system is in places where the presence of disabled, elderly, weak or with limited motorial skills people, it is suggested the supervision of responsible persons.

Don't stay inside the movement range of the door to avoid risk or danger situation. The children must be taken under control to avoid that they play inside the movement range of the door.

The door (complete lift) must be put out of service in case maintenance intervention are necessary or in case the door is not in perfect working conditions.

8.4 Installation personnel Requirements

The installation of the CDD5 system must be executed exclusively by competent and qualified technical personnel, having all the technical and professional requirements provided by the current active legislation in the installation country.

The installer **MUST** check the conformity and compatibility of the doors to be driven with the CDD5 system, especially the door system must be compliant to the standards and codes also related to the safety of use.

The installer **MUST** execute all the system installation and commissioning operations, and operate when present power supply voltage coming from electric cabinets and/or branch boxes, and he has to be enabled to perform all the electrical and mechanical operations.

The installer **MUST** provide to the final customer all the information about the system behaviour, in normal or inspection mode.

The installer is the only responsible subject of any wrong installation, or of any non-compliance to the instructions reported in the present manual. The installer is responsible towards the customer or others about any damage to people, things, animals that are caused by wrong installation of the system.

8.5 User requirements

The user must be aware of all the necessary information reported in the present document.

8.6 Standard and codes reference

The CDD5 product is compliant to the following directives:

- 2006/42/CE Machine
- 2014/35/CEE Markings
- 86/188/CEE acoustic emission, modified according to 98/24/CEE
- 2014/30/UE electromagnetic compatibility

And according to the following particular codes:

- EN12015/EN12016
- EN13015
- EN81-1 EN81-2 (1)
- AS1735 (1)

(1): compliance evaluated when coupled to the motors reported in the table “- Table 2: compatible motors data”.

The certified copy of the declaration of conformity for the product is reported in paragraph 9.1.



: the codes compliance to the maximum reversing force and to kinetic energy limit (maximum and average), is considered at own installer responsibility, that has to measure all the necessary values with appropriate instrumentation.

8.7 Warranty

Computec guarantees the optimal performances only if the original parts are directly sold and correctly installed.

Computec furthermore:

- Reserves the rights to undertakes updates of the present document, that will be downloadable from the website reported, in its last revision
- Inside its continuous improvement politics, it reserves the rights to implement design and materials modification of the product.

Therefore:

parts produced or added to the Computec product, without previous Computec check or permission, or non-original parts based on the Computec design (even if supplied by authorized retailer), cannot be considered under warranty, as the following conditions are cannot be insured:

1. Raw material quality control
2. Process quality control
3. Product quality control
4. Compliance product test according Computec specifications (resumed in the technical data).
5. Conformity test according to Computec specifications

8.8 Final considerations

The present user manual has been written, keeping in consideration that the company installing Computec product, satisfies the following requirements:

- The personnel responsible of the system installation or maintenance must apply the General and Specific codes for safety and hygiene (89/391/CEE – 89/654/CEE – 89/656/CEE).
- The personnel responsible of the system installation or maintenance must be familiar and trained to the use of the Computec product
- The devices used for the installation and maintenance, must be in optimal operating condition and has to be calibrated when necessary (89/655/CEE)

9 Annex

9.1 Product conformity declaration (DDC)